



FITTINGS UNLIMITED, INC.

Adapter & Fitting Specialist

IMPORT STEEL ADAPTER

Dallas, Texas
(800) 348-8467
Fax (817) 860-8517













Cleveland, Ohio
(800) 348-8467
Fax (817) 860-8517

Houston, Texas
(800) 633-5340
Fax (713) 672-8101

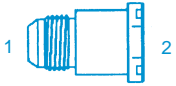
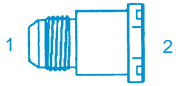

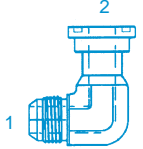
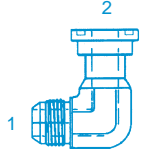
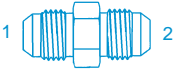
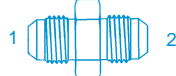
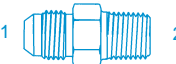
Salt Lake City, Utah
(800) 348-8467
Fax (817) 860-8517

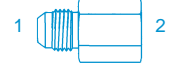
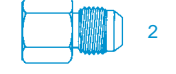
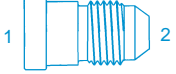
TUBE FITTINGS, J.I.C. - S.A.E.

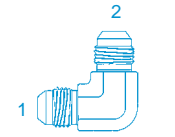
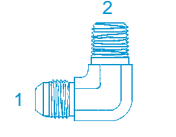
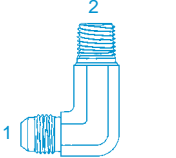
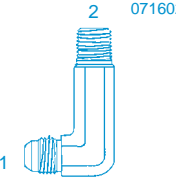
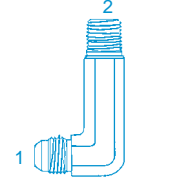
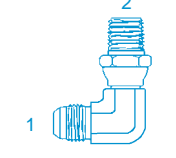
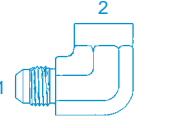
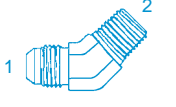
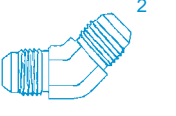
Dash Number	2	3	4	5	6	8	10	12	14	16	20	24	32
Tube O.D.	1/8	3/16	1/4	5/16	3/8	1/2	5/8	3/4	7/8	1	1-1/4	1-1/2	2
Straight Thread	5/16-24	3/8-24	7/16-20	1/2-20	9/16-18	3/4-16	7/8-14	1 1/16-12	1 3/16-12	1 5/16-12	1 5/8-12	1 7/8-12	2 1/2-12
Pipe Thread Std.	1/8-27	1/8-27	1/8-27	1/8-27	1/4-18	3/8-18	1/2-14	3/4-14	3/4-14	1-12 1/2	1 5/8-12	1 1/4-11 1/2	2-11 1/2

 <p>Y-0302-Short Nut</p>	<p>070112</p>  <p>Y-0304-C - 37° Cap Nut</p>	<p>070118</p>  <p>Y-0306 - Bulkhead Lock Nut</p>	 <p>Y-0306-N - Adjustable Lock Nut</p>	<p>070110</p>  <p>Y-0318 - 37° Nut</p>	<p>070115</p>  <p>Y-0319 - 37° Sleeve</p>
 <p>Y-1700-61 - Str. (1) Male 37° (2) O-Ring Flange</p>	 <p>Y-1700-62 (1) Male 37° (2) O-Ring Flange</p>	 <p>Y-1703-F-61 (1) Male 37° (2) O-Ring Flange</p>	 <p>Y-1703-F-62 (1) Male 37° (2) O-Ring Flange</p>	 <p>Y-1704-F-61 (1) Male 37° (2) O-Ring Flange</p>	 <p>Y-1704-F-62 (1) Male 37° (2) O-Ring Flange</p>
<p>070101</p>  <p>Y-2403 - Str. (1) (2) Male 37° Union</p>	<p>070119</p>  <p>Y-2403-LH - Str. (1) (2) Male 37° Union Large Hex</p>	<p>070102</p>  <p>Y-2404 - Str. (1) Male 37° (2) Male Pipe</p>	<p>070102L</p>  <p>Y-2404-L - Str. (1) Male 37° (2) Male Pipe-Long</p>	 <p>Y-2404-LL - Str. (1) Male 37° (2) Male Pipe -Ex. Long</p>	<p>070103</p>  <p>Y-2405 - Str. (1) Male 37° (2) Fem. Pipe</p>
<p>070123</p>  <p>Y-2406 - Str. Reducer & Expander (1) 37° Fem. (2) Male 37°</p>	 <p>Y-2407 - Reducer (1) 37° Fem. (2) Male 37°</p>	<p>070109</p>  <p>Y-2408 (1) Male 37° Plug</p>	<p>070201</p>  <p>Y-2500-F - 90° (1) (2) Male 37°</p>	<p>070202</p>  <p>Y-2501-F - 90° (1) Male 37° (2) Male Pipe</p>	<p>071502</p>  <p>Y-2501-F-L - 90° (1) Male 37° (2) Male Pipe-Long</p>
 <p>Y-2501-F-LL - 90° (1) Male 37° (2) Male Pipe-Ex. Long</p>	 <p>Y-2501-F-LLL - 90° (1) Male 37° (2) Male Pipe-Ex. Ex. Long</p>	 <p>Y-2501-F-S - 90° (1) Male 37° (2) Male Pipe Swivel</p>	<p>070203</p>  <p>Y-2502-F - 90° (1) Male 37° (2) Fem. Pipe</p>	<p>070302</p>  <p>Y-2503-F - 45° (1) Male 37° (2) Male Pipe</p>	<p>070301</p>  <p>Y-2504-F - 45° (1) (2) Male 37°</p>

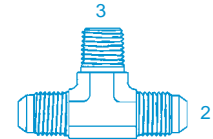
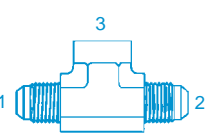
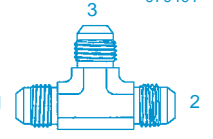
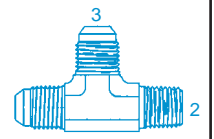
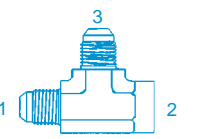
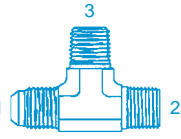
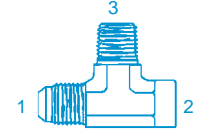
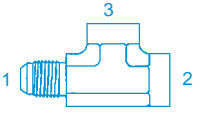
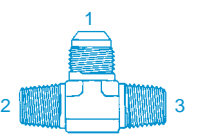
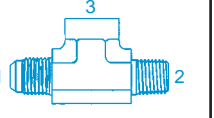
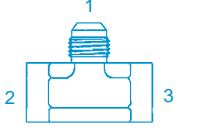
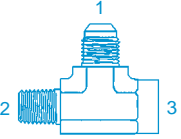
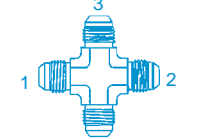
TUBE FITTINGS, J.I.C.- S.A.E., Continued

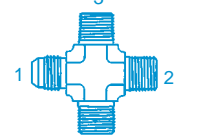
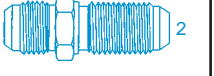
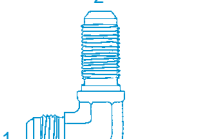
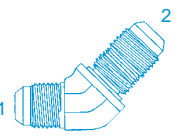
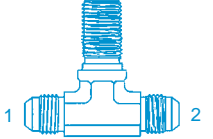
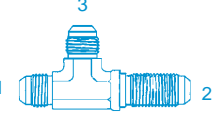
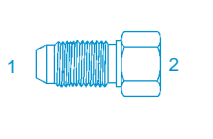
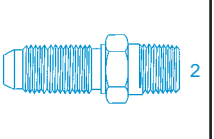
 <p>Y-2505-F - 45° (1) Male 37° (2) Fem. Pipe</p>	<p>070425</p>  <p>Y-2601-F - Tee (1) (2) Male 37° (3) Male Pipe</p>	<p>070427</p>  <p>Y-2602-F - Tee (1) (2) Male 37° (3) Fem. Pipe</p>	<p>070401</p>  <p>Y-2603-F - Tee (1) (2) (3) Male 37°</p>	<p>070424</p>  <p>Y-2605-F - Tee (1) (3) Male 37° (2) Male Pipe</p>	<p>070426</p>  <p>Y-2606-F - Tee (1) (3) Male 37° (2) Fem. Pipe</p>
 <p>Y-2607-F - Tee (1) Male 37° (2) (3) Male Pipe</p>	<p>070434</p>  <p>Y-2608-F - Tee (1) Male 37° (2) Fem. Pipe (3) Male Pipe</p>	 <p>Y-2609-F - Tee (1) Male 37° (2) (3) Fem. Pipe</p>	 <p>Y-2610-F - Tee (1) Male 37° (2) (3) Male Pipe</p>	<p>070435</p>  <p>Y-2611-F - Tee (1) Male 37° (2) Male Pipe (3) Fem. Pipe</p>	 <p>Y-2612-F - Tee (1) Male 37° (2) (3) Fem. Pipe</p>
 <p>Y-2613-F - Tee (1) Male 37° (2) Male Pipe (3) Fem. Pipe</p>	<p>070501</p>  <p>Y-2650-F - Cross (1) (2) (3) (4) Male 37°</p>	 <p>Y-2651-F (1) (3) (4) Male 37° (2) Male Pipe</p>	 <p>Y-2655-F - Cross (1) Male 37° (2) (3) (4) Male Pipe</p>	<p>070601</p>  <p>Y-2700 - Str. (1) Male 37° (2) Bulkhead 37°</p>	<p>070701</p>  <p>Y-2701-F - 90° (1) Male 37° (2) Bulkhead 37°</p>
<p>070801</p>  <p>Y-2702-F - 45° (1) Male 37° (2) Bulkhead 37°</p>	<p>070959</p>  <p>Y-2703-F - Tee (1) (2) Male 37° (3) Bulkhead 37°</p>	 <p>Y-2704-F - Tee (1) (3) Male 37° (2) Bulkhead 37°</p>	 <p>Y-2705 - Str. (1) Bulkhead 37° (2) Fem. Pipe</p>	 <p>Y-2706 - Str. (1) Bulkhead 37° (2) Male Pipe</p>	

BEADED HOSE ADAPTERS

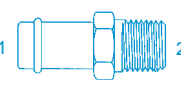
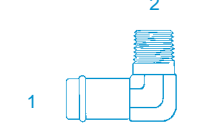
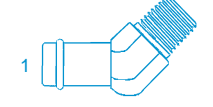
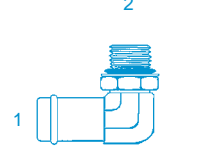
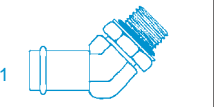
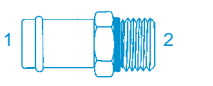
<p>430160</p>  <p>Y-4404 - Str. (1) Beaded (2) Male Pipe</p>	<p>430260</p>  <p>Y-4501-F - 90° (1) Beaded (2) Male Pipe</p>	<p>430360</p>  <p>Y-4503-F - 45° (1) Beaded (2) Male Pipe</p>	 <p>Y-4601-F-NWO - 90° (1) Beaded (2) Adj. O-Ring</p>	 <p>Y-4603-F-NWO - 45° (1) Beaded (2) Adj. O-Ring</p>	 <p>Y-4604-O - Str. (1) Beaded (2) Male O-Ring</p>
--	---	---	--	---	--





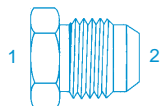
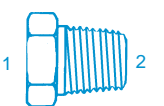



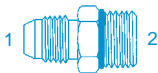
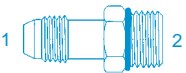
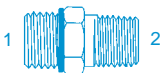

BRAZE FITTINGS FOR TUBING

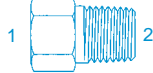
(Refer to "Tube Fittings, JIC-SAE" Chart for sizes)

 <p>Y-0403 (1) Bore (2) Male 37°</p>	 <p>Y-0404 (1) Bore (2) Male Pipe</p>			
--	---	--	--	--

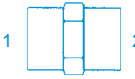
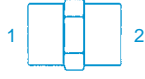
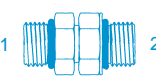
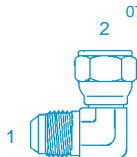
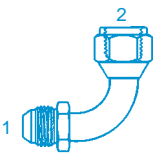
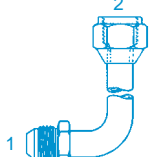
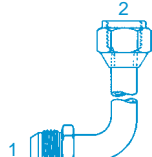
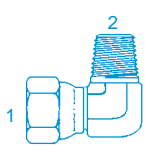
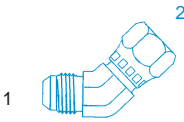
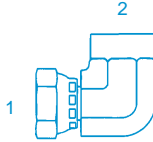
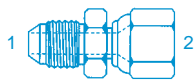
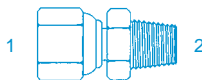

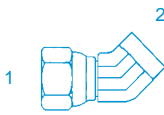
ADJUSTABLE & O-RING FITTINGS

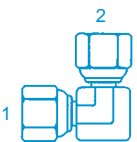
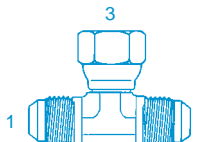
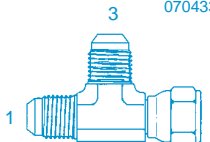
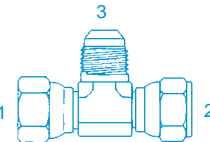
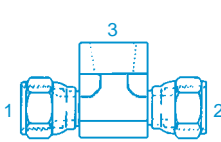
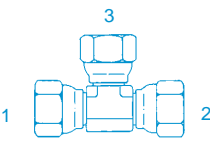
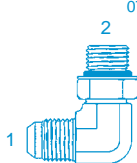
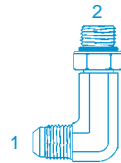
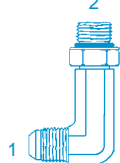
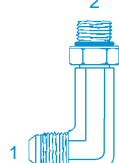
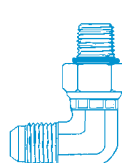
(Refer to Tube Fittings, "JIC-SAE" Chart for sizes)

 <p>4000 - O-Ring Buna-N 90 Duro</p>	<p>070122</p>  <p>Y-6400-O - Str. (1) Male 37° (2) Male O-Ring</p>	<p>070120</p>  <p>Y-6400-L-O - Str. (1) Male 37° (2) Male O-Ring -Long</p>	 <p>Y-6401-O - Str. (1) Male O-Ring (2) Male Pipe</p>	 <p>Y-6402-O - Str. (1) Male O-Ring (2) 37° Fem. Swivel</p>	 <p>Y-6404 - Str. (1) Fem. O-Ring (2) Male Pipe</p>
 <p>Y-6405-O - Str. (1) Male O-Ring (2) Fem. Pipe</p>	 <p>Y-6408-O - Str. (1) Male O-Ring Plug</p>	 <p>Y-6408-HHP-O (1) Hollow Hex Male O-Ring Plug</p>	 <p>Y-6410-O - Str. (1) Male O-Ring (2) Fem. O-Ring</p>	 <p>Y-6412 - Str. (1) Fem. O-Ring (2) Fem. Pipe</p>	 <p>Y-6413 - Str. (1) (2) Fem. O-Ring</p>
 <p>Y-6464-NWO - Str. (1) Male O-Ring (2) Adj. O-Ring</p>	<p>070221</p>  <p>Y-6500-F - 90° (1) Male 37° (2) 37° Fem. Swivel</p>	 <p>Y-6500-L - 90° (1) Male 37° (2) 37° Fem. Swivel-Long</p>	 <p>Y-6500-LL - 90° (1) Male 37° (2) 37° Fem. Swivel -Ex. Long</p>	 <p>Y-6500-LL-H-90° Heavy (1) Male 37° (2) 37° Fem. Swivel -Ex. Long</p>	 <p>Y-6501-F - 90° (1) 37° Fem. Swivel (2) Male Pipe</p>
 <p>Y-6502-F - 45° (1) Male 37° (2) 37° Fem. Swivel</p>	 <p>Y-6503-F - 90° (1) 37° Fem. Swivel (2) Fem. Pipe</p>	 <p>Y-6504 - Str. (1) Male 37° (2) 37° Fem. Swivel</p>	 <p>Y-6505 - Str. (1) 37° Fem. Swivel (2) Male Pipe</p>	 <p>Y-6506 - Str. (1) 37° Fem. Swivel (2) Fem. Pipe</p>	 <p>Y-6507-F - 45° (1) 37° Fem. Swivel (2) Fem. Pipe</p>
 <p>Y-6565 - Str. (1) (2) 37° Fem. Swivel</p>	 <p>Y-6566-F - 90° (1) (2) 37° Fem. Swivel</p>	<p>070433</p>  <p>Y-6600-F - Tee (1) (2) Male 37° (3) 37° Fem. Swivel</p>	 <p>Y-6602-F - Tee (1) (3) Male 37° (2) 37° Fem. Swivel</p>	 <p>Y-6603-F - Tee (1) (2) 37° Fem. Swivel (3) Male 37°</p>	 <p>Y-6605-F - Tee (1) (2) 37° Fem. Swivel (3) Fem. Pipe</p>
 <p>Y-6606-F - Tee (1) (2) (3) 37° Fem. Swivel</p>	<p>070220</p>  <p>Y-6801-F-NWO - 90° (1) Male 37° (2) Adj. O-Ring</p>	 <p>Y-6801-F-L-NWO - 90° (1) Male 37° (2) Adj. O-Ring-Long</p>	 <p>Y-6801-F-LL-NWO - 90° (1) Male 37° (2) Adj. O-Ring-Ex. Long</p>	 <p>Y-6801-F-LLL-NWO - 90° (1) Male 37° (2) Adj. O-Ring-Ex. Ex. Long</p>	 <p>Y-6801-F-S-O - 90° (1) Male 37° (2) Male O-Ring Swivel</p>

ADJUSTABLE & O-RING FITTINGS

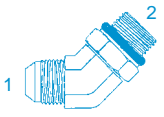
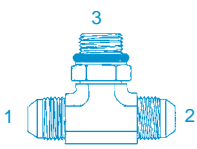
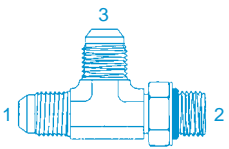
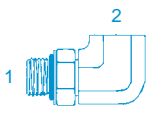
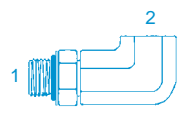
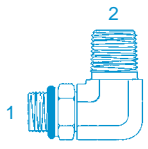
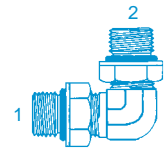
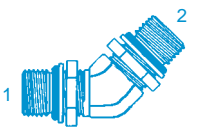
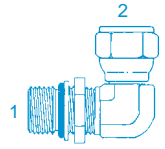
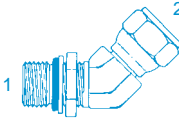
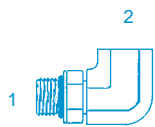
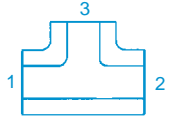
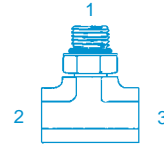
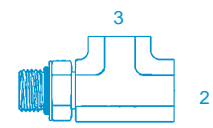
(Refer to Tube Fittings, "JIC-SAE" Chart for sizes)

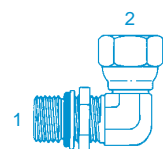
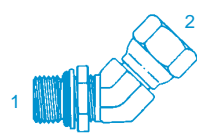
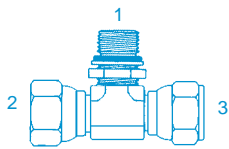
<p>070320</p>  <p>Y-6802-F-NWO - 45° (1) Male 37° (2) Adj. O-Ring</p>	<p>070429</p>  <p>Y-6803-F-NWO - Tee (1) (2) Male 37° (3) Adj. O-Ring</p>	<p>070428</p>  <p>Y-6804-F-NWO - Tee (1) (3) Male 37° (2) Adj. O-Ring</p>	 <p>Y-6805-F-NWO - 90° (1) Adj. O-Ring (2) Fem. Pipe</p>	 <p>Y-6805-F-LL-NWO - 90° (1) Adj. O-Ring (2) Fem. Pipe-Ex. Long</p>	 <p>Y-6806-F-NWO - 90° (1) Adj. O-Ring (2) Male Pipe</p>
 <p>Y-6807-F-NWO - 90° (1) (2) Adj. O-Ring</p>	 <p>Y-6808-F-NWO - 45° (1) (2) Adj. O-Ring</p>	 <p>Y-6809-F-NWO - 90° (1) Adj. O-Ring (2) 37° Fem. Swivel</p>	 <p>Y-6810-F-NWO - 45° (1) Adj. O-Ring (2) 37° Fem. Swivel</p>	 <p>Y-6815-F-NWO - 90° (1) Adj. O-Ring (2) Fem. O-Ring</p>	 <p>Y-6868-F - Tee (1) (2) (3) Fem. O-Ring</p>
 <p>Y-6870-F-NWO - Tee (1) Adj. O-Ring (2) (3) Fem. O-Ring</p>	 <p>Y-6871-F-NWO - Tee (1) Adj. O-Ring (2) (3) Fem. O-Ring</p>	 <p>Y-6900-O - Str. (1) Adj. O-Ring (2) Fem. Pipe Swivel</p>	 <p>Y-6901-F-NWO - 90° (1) Adj. O-Ring (2) Fem. Pipe Swivel</p>	 <p>Y-6902-F-NWO - 45° (1) Adj. O-Ring (2) Fem. Pipe Swivel</p>	 <p>Y-6911-F-NWO - Tee (1) Adj. O-Ring (2)(3) Fem. Pipe Swivel</p>

PIPE ADAPTER UNIONS

Refer to Chart below for Sizes



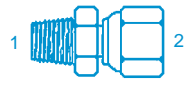
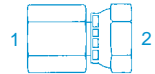
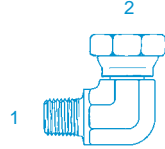
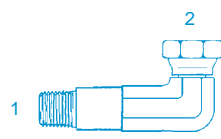
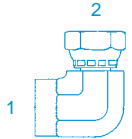
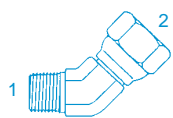
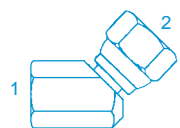
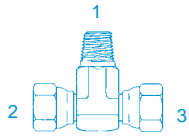
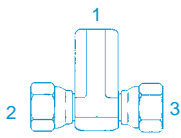
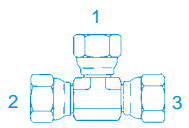



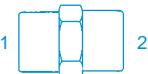

Dash Number	2	4	6	8	12	16	20	24	32
Pipe Thread Std. NPSM - NPTF	1/8-27	1/4-18	3/8-18	1/2-14	3/4-14	1-11 1/2	1 1/4-11 1/2	1 1/2-11 1/2	2-11 1/2

<p>140130</p>  <p>Y-1404 - Str. (1) Male Pipe (2) Fem. Pipe Swivel</p>	<p>140131</p>  <p>Y-1405 - Str. (1) Fem. Pipe (2) Fem. Pipe Swivel</p>	<p>140230</p>  <p>Y-1501-F - 90° (1) Male Pipe (2) Fem. Pipe Swivel</p>	 <p>Y-1501-F - LL - 90° (1) Male Pipe (2) Fem. Pipe Swivel</p>	 <p>Y-1502-F - 90° (1) Fem. Pipe (2) Fem. Pipe Swivel</p>
<p>140330</p>  <p>Y-1503-F - 45° (1) Male Pipe (2) Fem. Pipe Swivel</p>	 <p>Y-1504-F - 45° (1) Fem. Pipe (2) Fem. Pipe Swivel</p>	 <p>Y-1601-F - Tee (1) Male Pipe (2) (3) Fem. Pipe Swivel</p>	 <p>Y-1602-F - Tee (1) Fem. Pipe (2) (3) Fem. Pipe Swivel</p>	 <p>Y-1603-F - Tee (1) (2) (3) Fem. Pipe Swivel</p>

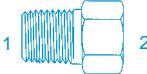
PIPE FITTINGS

Refer to Chart below for Sizes

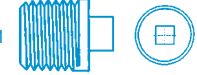
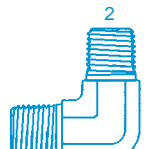
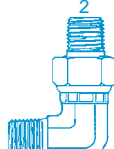
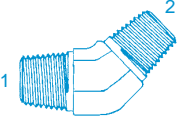
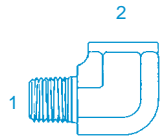
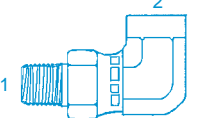
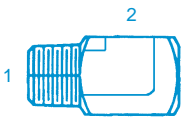
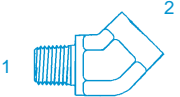
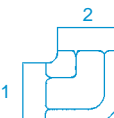
Dash Number	2	4	6	8	12	16	20	24	32
Pipe Thread Std. NPSM - NPTF	1/8-27	1/4-18	3/8-18	1/2-14	3/4-14	1-11/2	1 1/4-11 1/2	1 1/2-11 1/2	2-11 1/2

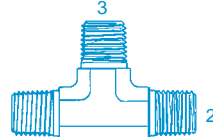
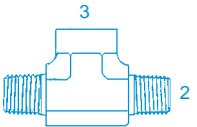
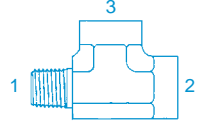
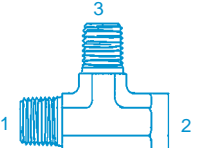
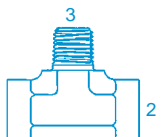
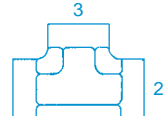
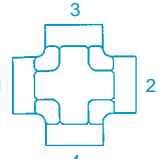
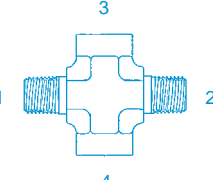
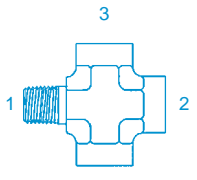
<p>140138</p>  <p>Y-5000 - Str. (1) (2) Fem. Pipe</p>	<p>140137</p>  <p>Y-5404 - Str. (1) (2) Male Pipe</p>	<p>140139</p>  <p>Y-5404-N - Str. Nipple (1) (2) Male Pipe</p>	<p>140139</p>  <p>Y-5405 - Str. (1) Male Pipe (2) Fem. Pipe</p>	<p>140140</p>  <p>Y-5406 - Str. Bushing (1) Male Pipe (2) Fem. Pipe</p>	 <p>Y-5406-C Pipe Cap</p>
 <p>Y-5406-HHP (1) Hollow Hex Pipe Plug</p>	<p>130109E</p>  <p>Y-5406-P - Plug (1) Pipe Plug</p>	 <p>Y-5406-SHP (1) Pipe plug Square Head Plug</p>	 <p>Y-5500-F - 90° (1) (2) Male Pipe</p>	 <p>Y-5500-F-S - 90° (1) Male Pipe (2) Male Pipe Swivel</p>	 <p>Y-5501-F - 45° (1) (2) Male Pipe</p>
<p>140239</p>  <p>Y-5502-F - 90° (1) Male Pipe (2) Fem. Pipe</p>	 <p>Y-5502-F-S - 90° (1) Male Pipe Swivel (2) Fem. Pipe</p>	 <p>Y-5502-F-SB (1) Male Pipe (2) Fem. Pipe</p>	<p>140339</p>  <p>Y-5503-F - 45° (1) Male Pipe (2) Fem. Pipe</p>	<p>140238</p>  <p>Y-5504-F - 90° (1) (2) Fem. Pipe</p>	<p>140338</p>  <p>Y-5505-F - 45° (1) (2) Fem. Pipe</p>
 <p>Y-5600-F - Tee (1) (2) (3) Male Pipe</p>	 <p>Y-5601-F - Tee (1) (2) Male Pipe (3) Fem. Pipe</p>	<p>140424</p>  <p>Y-5602-F - Tee (1) Male Pipe (2) (3) Fem. Pipe</p>	 <p>Y-5603-F - Tee (1) (3) Male Pipe (2) Fem. Pipe</p>	<p>140425</p>  <p>Y-5604-F - Tee (1) (2) Fem. Pipe (3) Male Pipe</p>	<p>140438</p>  <p>Y-5605-F - Tee (1) (2) (3) Fem. Pipe</p>
 <p>Y-5652-F - Cross (1) (2) (3) (4) Fem. Pipe</p>	 <p>Y-5653-F - Cross (1) (2) Male Pipe (3) (4) Fem. Pipe</p>	 <p>Y-5655-F - Cross (1) Male Pipe (2) (3) (4) Fem. Pipe</p>			