



FITTINGS UNLIMITED, INC.

Adapter & Fitting Specialist

www.fittingsunlimited.com

Price List

Prices subject to change without notice.

CORPORATE SALES

DALLAS, TX

3000 AVENUE F

ARLINGTON, TX 76011

(800) 348-8467 (817) 860-8517 FAX

CLEVELAND, OH

(800) 348-8467 (817) 860-8517 FAX

HOUSTON, TX

(800) 633-5340 (713) 672-8101 FAX

SALT LAKE CITY, UT

(800) 348-8467 (817) 860-8517 FAX

CANADA

CFA Industries – Fittings Unlimited, Inc.

305 INDUSTRIAL PARKWAY S., UNIT 11

AURORA, ONTARIO L4G 6X7

(877) 644-4403 (905) 713-3927 FAX

TERMS -

All invoices are 2%-10 Net 30 with approved credit. A 1½% finance charge will be assessed on all past due accounts. All accounts due and payable in Arlington, Tarrant County, Texas.

MINIMUM ORDER -

\$25.00 per order

POR -

Price On Request

RETURNS -

Fittings may be returned only with authorization from FITTINGS UNLIMITED, INC. - subject to our inspection and must be shipped freight prepaid within 30 days of original shipment. A restocking fee of 20% or \$10.00, whichever is greater, will apply. In case of shipping errors, notification must be made within 30 days to receive an adjustment. Special fittings and made to order items are non-cancelable and not returnable without written consent of FITTINGS UNLIMITED, INC.

Steel Live Swivels

*“It is the policy of Fittings Unlimited, Inc.
to maintain and improve our customer satisfaction by
providing hydraulic and pneumatic fittings and
accessories that consistently meet our customer’s
specified product and delivery requirements.”*

STEEL LIVE SWIVELS

Styles may vary from picture

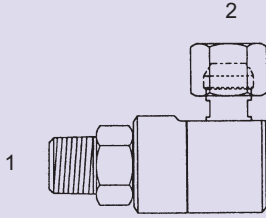

SLS-1501 - 90°

- (1) Male Pipe - Stem
- (2) Fem. Pipe Swivel - Barrel

| | |
|----------------|---------|
| SLS-1501-04-04 | 148.70 |
| SLS-1501-04-06 | 148.70 |
| SLS-1501-06-04 | 148.70 |
| SLS-1501-06-06 | 148.70 |
| SLS-1501-08-08 | 157.55 |
| SLS-1501-12-12 | 243.15 |
| SLS-1501-16-16 | 307.30 |
| SLS-1501-20-20 | 508.70 |
| SLS-1501-24-24 | 1183.60 |
| SLS-1501-32-32 | 1839.10 |

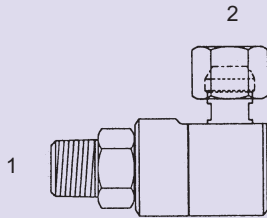

SLS-1501-4K - 90°

4000 PSI

- (1) Male Pipe - Stem
- (2) Fem. Pipe Swivel - Barrel

| | |
|-------------------|--------|
| SLS-1501-4K-08-08 | 295.95 |
|-------------------|--------|

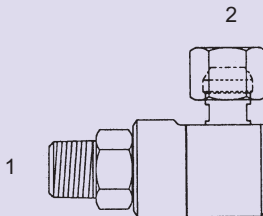

SLS-1501-5K - 90°

5000 PSI

- (1) Male Pipe - Stem
- (2) Fem. Pipe Swivel - Barrel

| | |
|-------------------|--------|
| SLS-1501-5K-04-04 | 286.10 |
| SLS-1501-5K-06-06 | 304.50 |

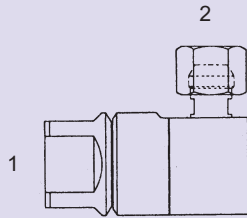

SLS-1502 - 90°

- (1) Fem. Pipe - Stem
- (2) Fem. Pipe Swivel - Barrel

| | |
|----------------|---------|
| SLS-1502-04-04 | 148.70 |
| SLS-1502-04-06 | 148.70 |
| SLS-1502-06-04 | 148.70 |
| SLS-1502-06-06 | 148.70 |
| SLS-1502-08-08 | 157.55 |
| SLS-1502-12-12 | 243.15 |
| SLS-1502-16-16 | 307.30 |
| SLS-1502-20-20 | 508.70 |
| SLS-1502-24-24 | 1183.60 |
| SLS-1502-32-32 | 1839.10 |

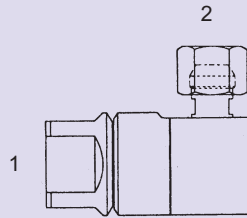

SLS-1502-4K - 90°

4000 PSI

- (1) Fem. Pipe - Stem
- (2) Fem. Pipe Swivel - Barrel

| | |
|-------------------|--------|
| SLS-1502-4K-08-08 | 304.30 |
|-------------------|--------|

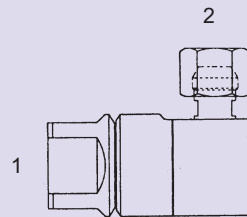

SLS-1502-5K - 90°

5000 PSI

- (1) Fem. Pipe - Stem
- (2) Fem. Pipe Swivel - Barrel

| | |
|-------------------|--------|
| SLS-1502-5K-06-06 | 287.85 |
|-------------------|--------|

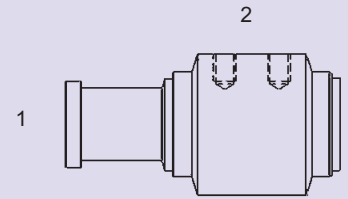

SLS-1704-61 - 90°

- (1) O-Ring Flange Head - Stem
- (2) Flange Block - Tapped Holes - Barrel
Code 61

| | |
|-------------------|---------|
| SLS-1704-61-12-12 | 1001.85 |
| SLS-1704-61-16-16 | 1280.90 |
| SLS-1704-61-20-20 | 1401.25 |
| SLS-1704-61-24-24 | 1930.55 |
| SLS-1704-61-32-32 | 2912.00 |
| SLS-1704-61-40-40 | 3850.45 |

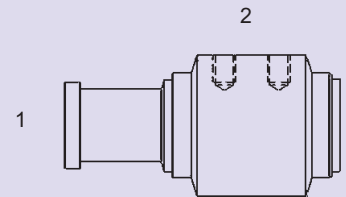

SLS-1704-62 - 90°

- (1) O-Ring Flange Head - Stem
- (2) Flange Block - Tapped Holes - Barrel
Code 62

| | |
|-------------------|---------|
| SLS-1704-62-08-08 | 978.15 |
| SLS-1704-62-12-12 | 1284.75 |
| SLS-1704-62-16-16 | 1427.00 |
| SLS-1704-62-20-20 | 1891.25 |
| SLS-1704-62-24-24 | 2942.25 |
| SLS-1704-62-32-32 | 3916.95 |

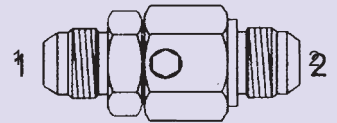

SLS-2403 - Str.

- (1) Male JIC - Stem
- (2) Male JIC - Barrel

| | |
|----------------|---------|
| SLS-2403-06-06 | 123.60 |
| SLS-2403-08-08 | 123.60 |
| SLS-2403-10-10 | 143.95 |
| SLS-2403-12-12 | 143.95 |
| SLS-2403-16-16 | 258.15 |
| SLS-2403-20-20 | 467.60 |
| SLS-2403-24-24 | 1079.20 |
| SLS-2403-32-32 | 1725.70 |

STEEL LIVE SWIVELS

Styles may vary from picture

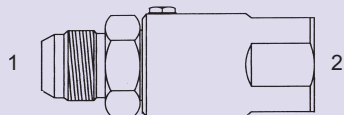

SLS-2405 - Str.

- (1) Male JIC- Stem
- (2) Fem. Pipe - Barrel

| | |
|----------------|---------|
| SLS-2405-04-04 | 146.40 |
| SLS-2405-06-04 | 146.40 |
| SLS-2405-08-06 | 151.55 |
| SLS-2405-08-08 | 160.40 |
| SLS-2405-10-08 | 160.40 |
| SLS-2405-12-12 | 200.85 |
| SLS-2405-16-16 | 273.45 |
| SLS-2405-20-20 | 467.60 |
| SLS-2405-24-24 | 1102.00 |

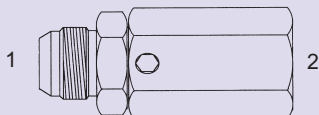

SLS-2412 - Str.

- (1) Male JIC- Stem
- (2) Fem. JIC - Barrel

| | |
|----------------|--------|
| SLS-2412-04-04 | 146.40 |
| SLS-2412-06-06 | 146.40 |
| SLS-2412-08-08 | 160.40 |
| SLS-2412-10-10 | 160.40 |
| SLS-2412-12-12 | 200.85 |
| SLS-2412-16-16 | 273.45 |
| SLS-2412-20-20 | 467.60 |

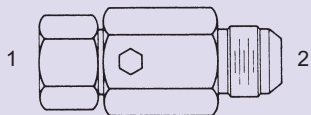

SLS-2421 - Str.

- (1) Fem. JIC- Stem
- (2) Male JIC - Barrel

| | |
|----------------|---------|
| SLS-2421-06-06 | 123.60 |
| SLS-2421-08-06 | 123.60 |
| SLS-2421-08-08 | 123.60 |
| SLS-2421-10-10 | 144.00 |
| SLS-2421-12-12 | 144.00 |
| SLS-2421-14-14 | 214.60 |
| SLS-2421-16-16 | 258.15 |
| SLS-2421-20-20 | 481.45 |
| SLS-2421-24-24 | 1079.25 |
| SLS-2421-32-32 | 1725.70 |

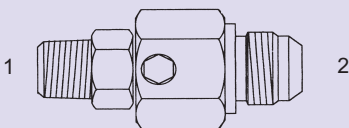

SLS-2471 - Str.

- (1) Male Pipe - Stem
- (2) Male JIC - Barrel

| | |
|----------------|---------|
| SLS-2471-04-04 | 254.50 |
| SLS-2471-04-06 | 123.60 |
| SLS-2471-04-08 | 123.60 |
| SLS-2471-06-06 | 123.60 |
| SLS-2471-06-08 | 123.60 |
| SLS-2471-08-08 | 143.95 |
| SLS-2471-08-10 | 144.00 |
| SLS-2471-08-12 | 143.95 |
| SLS-2471-12-10 | 143.95 |
| SLS-2471-12-12 | 144.00 |
| SLS-2471-16-16 | 258.15 |
| SLS-2471-20-20 | 467.60 |
| SLS-2471-24-24 | 1079.25 |
| SLS-2471-32-32 | 1725.70 |

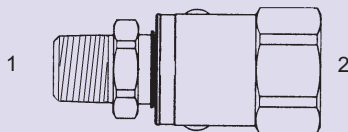

SLS-2472 - Str.

- (1) Male Pipe - Stem
- (2) Fem. JIC - Barrel

| | |
|----------------|--------|
| SLS-2472-06-06 | 273.85 |
| SLS-2472-08-08 | 301.90 |

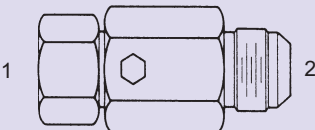

SLS-2481 - Str.

- (1) Fem. Pipe - Stem
- (2) Male JIC - Barrel

| | |
|----------------|---------|
| SLS-2481-04-04 | 280.05 |
| SLS-2481-04-06 | 123.60 |
| SLS-2481-06-06 | 123.60 |
| SLS-2481-06-08 | 123.60 |
| SLS-2481-08-08 | 143.95 |
| SLS-2481-08-10 | 144.00 |
| SLS-2481-08-12 | 143.95 |
| SLS-2481-12-10 | 143.95 |
| SLS-2481-12-12 | 144.00 |
| SLS-2481-16-16 | 258.15 |
| SLS-2481-20-20 | 481.45 |
| SLS-2481-24-24 | 1079.25 |
| SLS-2481-32-32 | 1725.70 |

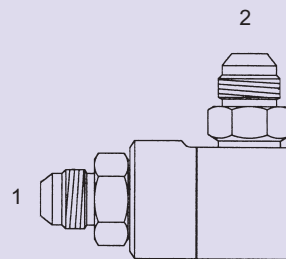

SLS-2500 - 90°

- (1) Male JIC - Stem
- (2) Male JIC - Barrel

| | |
|----------------|---------|
| SLS-2500-04-04 | 151.80 |
| SLS-2500-05-05 | 148.70 |
| SLS-2500-05-06 | 148.70 |
| SLS-2500-06-05 | 148.70 |
| SLS-2500-06-06 | 148.70 |
| SLS-2500-06-08 | 148.70 |
| SLS-2500-08-06 | 148.70 |
| SLS-2500-08-08 | 148.70 |
| SLS-2500-08-10 | 157.50 |
| SLS-2500-10-08 | 157.50 |
| SLS-2500-10-10 | 157.55 |
| SLS-2500-12-12 | 243.15 |
| SLS-2500-16-16 | 307.30 |
| SLS-2500-20-20 | 508.70 |
| SLS-2500-24-24 | 1183.60 |
| SLS-2500-32-32 | 1839.10 |

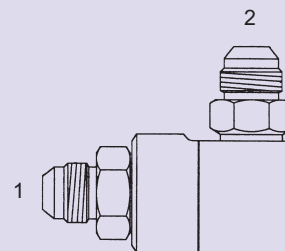

SLS-2500-4K - 90°

4000 PSI

- (1) Male JIC - Stem
- (2) Male JIC - Barrel

| | |
|-------------------|--------|
| SLS-2500-4K-12-12 | 404.25 |
|-------------------|--------|

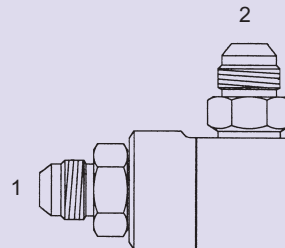

SLS-2500-5K - 90°

5000 PSI

- (1) Male JIC - Stem
- (2) Male JIC - Barrel

| | |
|-------------------|--------|
| SLS-2500-5K-05-05 | 260.10 |
| SLS-2500-5K-05-06 | 260.10 |
| SLS-2500-5K-06-05 | 260.10 |
| SLS-2500-5K-06-06 | 260.10 |
| SLS-2500-5K-06-08 | 260.10 |
| SLS-2500-5K-08-06 | 260.10 |
| SLS-2500-5K-08-08 | 260.10 |
| SLS-2500-5K-08-10 | 276.65 |
| SLS-2500-5K-10-08 | 276.65 |
| SLS-2500-5K-10-10 | 276.65 |

STEEL LIVE SWIVELS

Styles may vary from picture

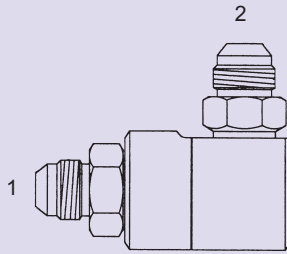

SLS-2500-LH - 90°

Large Hex
(1) Male JIC - Stem
(2) Male JIC - Barrel

SLS-2500-LH-08-08 157.50

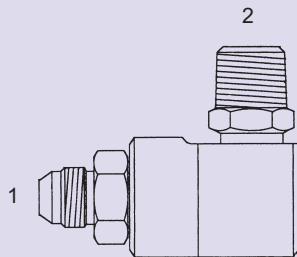

SLS-2501 - 90°

(1) Male JIC - Stem
(2) Male Pipe - Barrel

| | |
|----------------|---------|
| SLS-2501-04-04 | 151.80 |
| SLS-2501-05-04 | 148.70 |
| SLS-2501-05-06 | 148.70 |
| SLS-2501-06-04 | 148.70 |
| SLS-2501-06-06 | 148.70 |
| SLS-2501-08-06 | 148.70 |
| SLS-2501-08-08 | 157.50 |
| SLS-2501-10-06 | 189.15 |
| SLS-2501-10-08 | 157.55 |
| SLS-2501-12-12 | 243.15 |
| SLS-2501-16-16 | 307.30 |
| SLS-2501-20-20 | 508.70 |
| SLS-2501-24-24 | 1183.60 |
| SLS-2501-32-32 | 1839.10 |

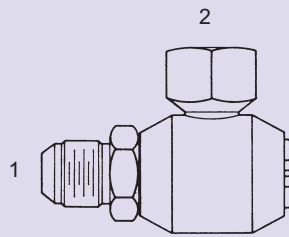

SLS-2502 - 90°

(1) Male JIC - Stem
(2) Fem. Pipe - Barrel

| | |
|----------------|---------|
| SLS-2502-04-04 | 151.80 |
| SLS-2502-05-06 | 148.70 |
| SLS-2502-06-04 | 148.70 |
| SLS-2502-06-06 | 148.70 |
| SLS-2502-08-06 | 148.70 |
| SLS-2502-08-08 | 157.55 |
| SLS-2502-10-08 | 157.55 |
| SLS-2502-12-12 | 243.15 |
| SLS-2502-16-16 | 307.30 |
| SLS-2502-20-20 | 580.85 |
| SLS-2502-24-24 | 1183.60 |
| SLS-2502-32-32 | 1839.10 |

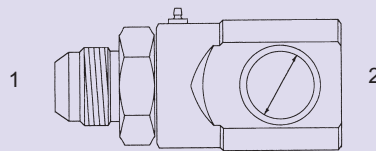

SLS-2502-SB - 90°

(1) Male JIC - Stem
(2) Fem. Pipe - Barrel
(Short Body)

| | |
|-------------------|---------|
| SLS-2502-SB-08-06 | 169.00 |
| SLS-2502-SB-10-06 | 169.00 |
| SLS-2502-SB-10-08 | 169.00 |
| SLS-2502-SB-12-12 | 404.75 |
| SLS-2502-SB-16-16 | 287.70 |
| SLS-2502-SB-20-20 | 472.00 |
| SLS-2502-SB-24-24 | 1102.00 |

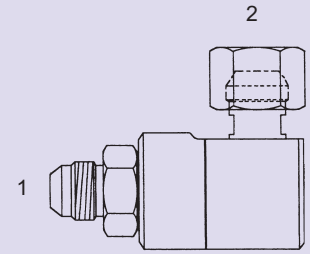

SLS-2519 - 90°

(1) Male JIC - Stem
(2) Fem. Pipe Swivel - Barrel

| | |
|----------------|---------|
| SLS-2519-05-04 | 148.70 |
| SLS-2519-05-06 | 148.70 |
| SLS-2519-06-04 | 148.70 |
| SLS-2519-06-06 | 148.70 |
| SLS-2519-08-04 | 148.70 |
| SLS-2519-08-06 | 148.70 |
| SLS-2519-08-08 | 157.50 |
| SLS-2519-10-08 | 157.55 |
| SLS-2519-12-12 | 243.15 |
| SLS-2519-16-16 | 307.30 |
| SLS-2519-20-20 | 508.70 |
| SLS-2519-24-24 | 1183.60 |
| SLS-2519-32-32 | 1839.10 |

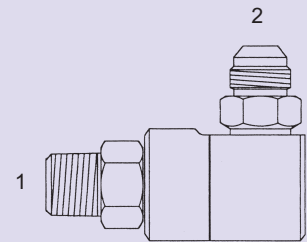

SLS-2571 - 90°

(1) Male Pipe - Stem
(2) Male JIC - Barrel

| | |
|----------------|---------|
| SLS-2571-04-04 | 151.80 |
| SLS-2571-04-05 | 148.70 |
| SLS-2571-04-06 | 148.70 |
| SLS-2571-04-08 | 148.70 |
| SLS-2571-06-05 | 148.70 |
| SLS-2571-06-06 | 148.70 |
| SLS-2571-06-08 | 148.70 |
| SLS-2571-08-08 | 157.55 |
| SLS-2571-08-10 | 157.55 |
| SLS-2571-12-12 | 243.15 |
| SLS-2571-16-16 | 307.30 |
| SLS-2571-20-20 | 508.70 |
| SLS-2571-24-24 | 1183.60 |
| SLS-2571-32-32 | 1839.10 |

STEEL LIVE SWIVELS

Styles may vary from picture

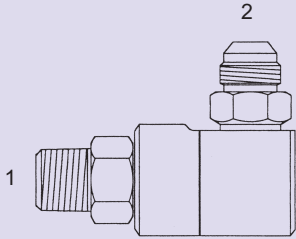

SLS-2571-4K - 90°

4000 PSI

- (1) Male Pipe - Stem
- (2) Male JIC - Barrel

SLS-2571-4K-12-12

338.50

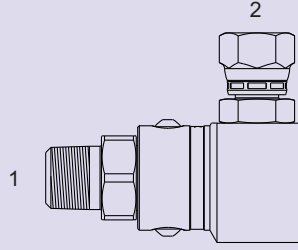

SLS-2573-4K - 90°

4000 PSI

- (1) Male Pipe - Stem
- (2) Female JIC - Barrel

SLS-2573-4K-12-12

464.45

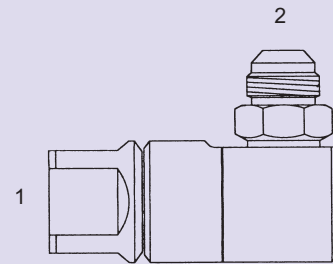

SLS-2581-4K - 90°

4000 PSI

- (1) Fem. Pipe - Stem
- (2) Male JIC - Barrel

SLS-2581-4K-12-12

404.55

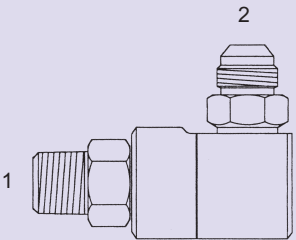

SLS-2571-5K - 90°

5000 PSI

- (1) Male Pipe - Stem
- (2) Male JIC - Barrel

SLS-2571-5K-04-04

253.65

SLS-2571-5K-06-06

262.90

SLS-2571-5K-08-08

327.35

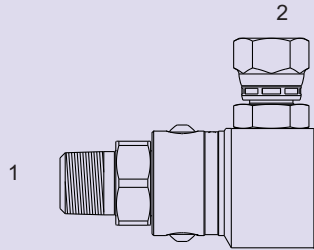

SLS-2573-5K - 90°

5000 PSI

- (1) Male Pipe - Stem
- (2) Female JIC - Barrel

SLS-2573-5K-08-08

325.00

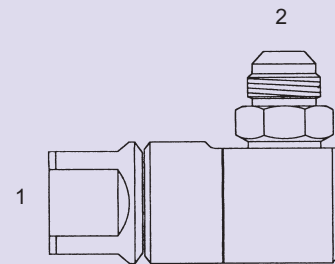

SLS-2581-5K - 90°

5000 PSI

- (1) Fem. Pipe - Stem
- (2) Male JIC - Barrel

SLS-2581-5K-06-06

290.55

SLS-2581-5K-08-08

322.15

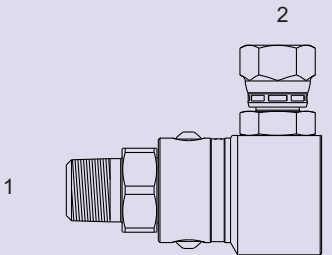

SLS-2573 - 90°

- (1) Male Pipe - Stem
- (2) Female JIC - Barrel

SLS-2573-16-16

487.85

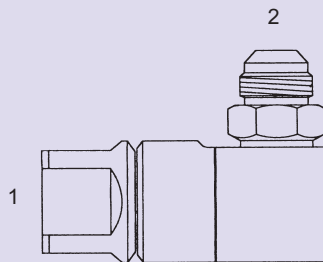

SLS-2581 - 90°

- (1) Fem. Pipe - Stem
- (2) Male JIC - Barrel

SLS-2581-04-04

151.85

SLS-2581-04-05

148.70

SLS-2581-04-06

148.70

SLS-2581-06-05

148.70

SLS-2581-06-06

148.70

SLS-2581-06-08

148.70

SLS-2581-08-08

157.55

SLS-2581-08-10

157.55

SLS-2581-12-12

243.15

SLS-2581-16-16

307.30

SLS-2581-20-20

508.70

SLS-2581-24-24

1183.60

SLS-2581-32-32

1839.10

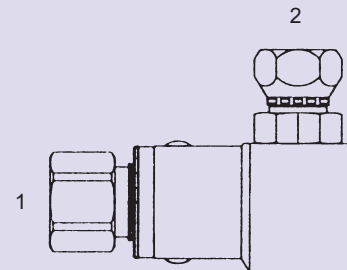

SLS-2583 - 90°

- (1) Fem. Pipe - Stem
- (2) Fem. JIC Swivel - Barrel

SLS-2583-04-04

162.15

SLS-2583-06-04

162.15

SLS-2583-06-06

169.00

SLS-2583-08-08

169.00

STEEL LIVE SWIVELS

Styles may vary from picture

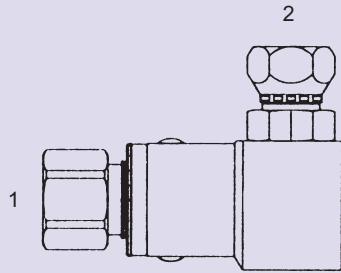

SLS-2583-4K - 90°

4000 PSI

- (1) Fem. Pipe - Stem
- (2) Fem. JIC Swivel - Barrel

| | |
|-------------------|---------|
| SLS-2583-4K-08-10 | 169.00 |
| SLS-2583-4K-12-12 | 231.60 |
| SLS-2583-4K-16-16 | 287.70 |
| SLS-2583-4K-20-20 | 471.90 |
| SLS-2583-4K-24-24 | 1102.00 |

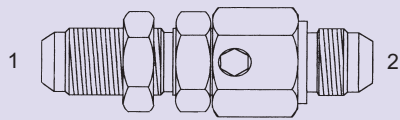

SLS-2710 - Str.

- (1) Male JIC Bulkhead - Stem
- (2) Male JIC - Barrel

| | |
|----------------|--------|
| SLS-2710-08-08 | 180.75 |
| SLS-2710-10-10 | 180.75 |
| SLS-2710-12-12 | 226.25 |
| SLS-2710-16-16 | 294.75 |

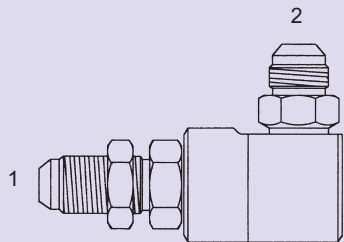

SLS-2711 - 90°

- (1) Male JIC Bulkhead - Stem
- (2) Male JIC - Barrel

| | |
|----------------|--------|
| SLS-2711-08-08 | 214.90 |
| SLS-2711-12-12 | 276.30 |
| SLS-2711-16-16 | 354.90 |
| SLS-2711-20-20 | 566.75 |

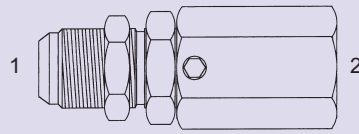

SLS-2712 - Str.

- (1) Male JIC Bulkhead - Stem
- (2) Fem. JIC - Barrel

| | |
|----------------|--------|
| SLS-2712-08-08 | 180.75 |
| SLS-2712-10-10 | 180.75 |
| SLS-2712-12-12 | 226.25 |
| SLS-2712-16-16 | 294.75 |
| SLS-2712-20-20 | 487.90 |

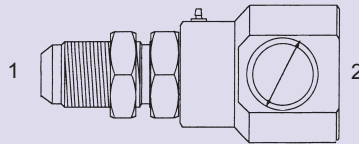

SLS-2715-SB - 90°

- (1) Male JIC Bulkhead - Stem
- (2) Fem. O-Ring - Barrel (Short Body)

| | |
|-------------------|--------|
| SLS-2715-SB-08-08 | 182.60 |
| SLS-2715-SB-10-08 | 182.60 |
| SLS-2715-SB-12-12 | 244.45 |
| SLS-2715-SB-16-16 | 310.15 |
| SLS-2715-SB-20-20 | 493.10 |

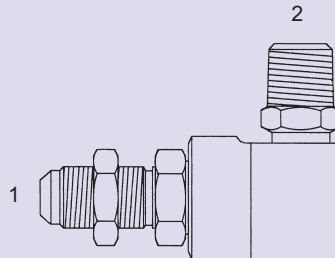

SLS-2717 - 90°

- (1) Male JIC Bulkhead - Stem
- (2) Male Pipe - Barrel

| | |
|----------------|--------|
| SLS-2717-08-06 | 214.90 |
| SLS-2717-08-08 | 214.90 |
| SLS-2717-10-08 | 214.90 |
| SLS-2717-12-12 | 276.30 |
| SLS-2717-16-16 | 354.90 |
| SLS-2717-20-20 | 566.75 |

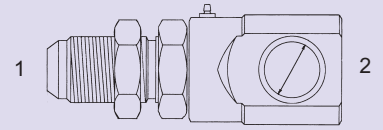

SLS-2718-SB - 90°

- (1) Male JIC Bulkhead - Stem
- (2) Fem. Pipe - Barrel (Short Body)

| | |
|-------------------|--------|
| SLS-2718-SB-08-06 | 189.15 |
| SLS-2718-SB-08-08 | 182.60 |
| SLS-2718-SB-10-06 | 182.60 |
| SLS-2718-SB-10-08 | 182.60 |
| SLS-2718-SB-12-12 | 244.45 |
| SLS-2718-SB-16-16 | 310.15 |
| SLS-2718-SB-20-20 | 493.10 |

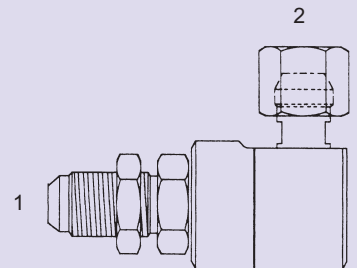

SLS-2719 - 90°

- (1) Male JIC Bulkhead - Stem
- (2) Fem. Pipe Swivel - Barrel

| | |
|----------------|--------|
| SLS-2719-08-06 | 214.90 |
| SLS-2719-08-08 | 214.90 |
| SLS-2719-10-08 | 214.90 |
| SLS-2719-12-12 | 276.30 |
| SLS-2719-16-16 | 354.90 |
| SLS-2719-20-20 | 566.75 |

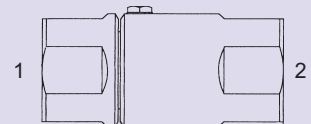

SLS-5000 - Str.

- (1) Fem. Pipe - Stem
- (2) Fem. Pipe - Barrel

| | |
|----------------|---------|
| SLS-5000-02-02 | 173.00 |
| SLS-5000-04-04 | 123.60 |
| SLS-5000-04-06 | 123.60 |
| SLS-5000-06-06 | 123.60 |
| SLS-5000-08-08 | 144.00 |
| SLS-5000-12-08 | 143.95 |
| SLS-5000-12-12 | 144.00 |
| SLS-5000-16-16 | 258.15 |
| SLS-5000-20-20 | 467.60 |
| SLS-5000-24-24 | 1079.25 |
| SLS-5000-32-32 | 1725.70 |
| SLS-5000-40-40 | 2269.85 |

STEEL LIVE SWIVELS

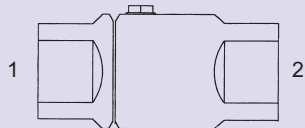

SLS-5000-HP - Str.
High Pressure - 10,000 PSI
(1) Fem. Pipe - Stem
(2) Fem. Pipe - Barrel

SLS-5000-HP-08-08 556.75

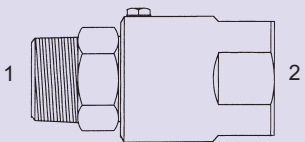

SLS-5405 - Str.
(1) Male Pipe - Stem
(2) Fem. Pipe - Barrel

| | |
|----------------|---------|
| SLS-5405-02-02 | 173.00 |
| SLS-5405-04-04 | 123.60 |
| SLS-5405-04-06 | 123.60 |
| SLS-5405-06-04 | 123.60 |
| SLS-5405-06-06 | 123.60 |
| SLS-5405-08-08 | 144.00 |
| SLS-5405-08-12 | 143.95 |
| SLS-5405-12-08 | 143.95 |
| SLS-5405-12-12 | 144.00 |
| SLS-5405-16-16 | 258.15 |
| SLS-5405-20-20 | 467.60 |
| SLS-5405-24-24 | 1079.25 |
| SLS-5405-32-32 | 1725.70 |

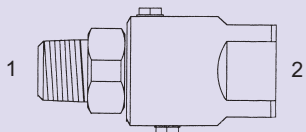

SLS-5405-HP - Str.
High Pressure - 10,000 PSI
(1) Male Pipe - Stem
(2) Fem. Pipe - Barrel

SLS-5405-HP-08-08 556.75

Styles may vary from picture

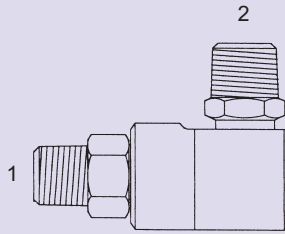

SLS-5500 - 90°
(1) Male Pipe - Stem
(2) Male Pipe - Barrel

| | |
|----------------|---------|
| SLS-5500-04-04 | 148.70 |
| SLS-5500-04-06 | 148.70 |
| SLS-5500-06-04 | 148.70 |
| SLS-5500-06-06 | 148.70 |
| SLS-5500-06-08 | 189.15 |
| SLS-5500-08-06 | 189.15 |
| SLS-5500-08-08 | 157.55 |
| SLS-5500-12-12 | 243.15 |
| SLS-5500-16-16 | 307.30 |
| SLS-5500-20-20 | 508.70 |
| SLS-5500-24-24 | 1183.60 |
| SLS-5500-32-32 | 1839.10 |

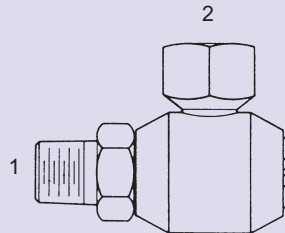

SLS-5502 - 90°
(1) Male Pipe - Stem
(2) Fem. Pipe - Barrel

| | |
|----------------|---------|
| SLS-5502-04-04 | 148.70 |
| SLS-5502-04-06 | 148.70 |
| SLS-5502-06-04 | 148.70 |
| SLS-5502-06-06 | 148.70 |
| SLS-5502-08-08 | 157.55 |
| SLS-5502-12-12 | 243.15 |
| SLS-5502-16-16 | 307.30 |
| SLS-5502-20-20 | 580.85 |
| SLS-5502-24-24 | 1183.60 |
| SLS-5502-32-32 | 1839.10 |

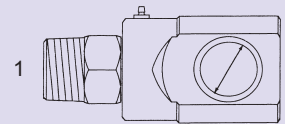

SLS-5502-SB - 90°
(1) Male Pipe - Stem
(2) Fem. Pipe - Barrel
(Short Body)

| | |
|-------------------|---------|
| SLS-5502-SB-02-02 | 190.70 |
| SLS-5502-SB-04-04 | 162.15 |
| SLS-5502-SB-06-06 | 169.00 |
| SLS-5502-SB-08-08 | 169.00 |
| SLS-5502-SB-12-12 | 231.55 |
| SLS-5502-SB-16-16 | 287.70 |
| SLS-5502-SB-20-20 | 472.00 |
| SLS-5502-SB-24-24 | 1101.90 |
| SLS-5502-SB-32-32 | 2163.40 |

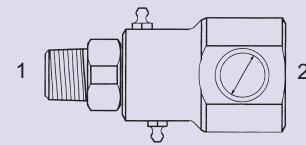

SLS-5502-SB-HP - 90°
High Pressure - 10,000 PSI
(1) Male Pipe - Stem
(2) Fem. Pipe - Barrel
(Short Body)

SLS-5502-SB-HP-08-08 582.90

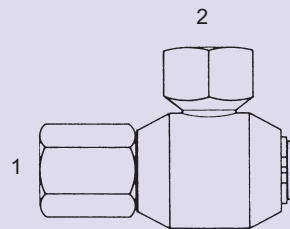

SLS-5504 - 90°
(1) Fem. Pipe - Stem
(2) Fem. Pipe - Barrel

| | |
|----------------|---------|
| SLS-5504-04-04 | 148.70 |
| SLS-5504-04-06 | 148.70 |
| SLS-5504-06-04 | 148.70 |
| SLS-5504-06-06 | 148.70 |
| SLS-5504-08-08 | 157.55 |
| SLS-5504-12-12 | 243.15 |
| SLS-5504-16-16 | 307.30 |
| SLS-5504-20-20 | 580.85 |
| SLS-5504-24-24 | 1183.60 |
| SLS-5504-32-32 | 1839.10 |

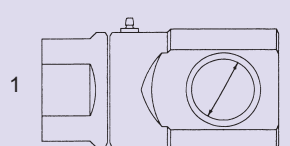

SLS-5504-SB - 90°
(1) Fem. Pipe - Stem
(2) Fem. Pipe - Barrel
(Short Body)

| | |
|-------------------|---------|
| SLS-5504-SB-02-02 | 190.70 |
| SLS-5504-SB-04-04 | 162.15 |
| SLS-5504-SB-06-06 | 169.00 |
| SLS-5504-SB-08-08 | 169.00 |
| SLS-5504-SB-12-12 | 231.55 |
| SLS-5504-SB-16-16 | 287.70 |
| SLS-5504-SB-20-20 | 472.00 |
| SLS-5504-SB-24-24 | 1102.00 |
| SLS-5504-SB-32-32 | 2163.40 |

STEEL LIVE SWIVELS

Styles may vary from picture

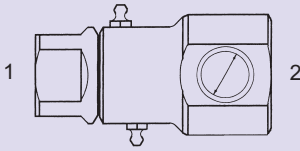

SLS-5504-SB-HP - 90°

High Pressure - 10,000 PSI

- (1) Fem. Pipe - Stem
- (2) Fem. Pipe - Barrel
(Short Body)

SLS-5504-SB-HP-08-08 582.90

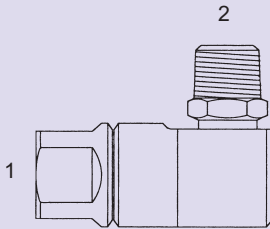

SLS-5587 - 90°

- (1) Fem. Pipe - Stem
- (2) Male Pipe - Barrel

| | |
|----------------|---------|
| SLS-5587-04-04 | 148.70 |
| SLS-5587-04-06 | 148.70 |
| SLS-5587-06-04 | 148.70 |
| SLS-5587-06-06 | 148.70 |
| SLS-5587-06-08 | 189.15 |
| SLS-5587-08-06 | 189.15 |
| SLS-5587-08-08 | 157.55 |
| SLS-5587-12-12 | 243.15 |
| SLS-5587-16-16 | 307.30 |
| SLS-5587-20-20 | 508.70 |
| SLS-5587-24-24 | 1183.60 |
| SLS-5587-32-32 | 1839.10 |

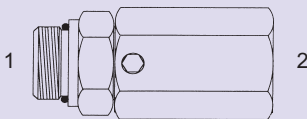

SLS-6402-O - Str.

- (1) Male O-Ring - Stem
- (2) Fem. JIC - Barrel

| | |
|------------------|---------|
| SLS-6402-06-06-O | 146.40 |
| SLS-6402-08-08-O | 182.25 |
| SLS-6402-10-10-O | 160.40 |
| SLS-6402-12-12-O | 200.85 |
| SLS-6402-16-16-O | 273.45 |
| SLS-6402-20-20-O | 467.60 |
| SLS-6402-24-24-O | 1102.00 |

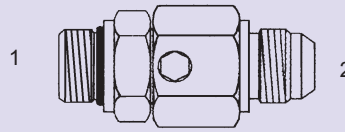

SLS-6441-O - Str.

- (1) Male O-Ring - Stem
- (2) Male JIC - Barrel

| | |
|------------------|---------|
| SLS-6441-04-04-O | 266.55 |
| SLS-6441-06-06-O | 123.60 |
| SLS-6441-08-06-O | 123.60 |
| SLS-6441-08-08-O | 123.60 |
| SLS-6441-10-08-O | 143.95 |
| SLS-6441-10-10-O | 143.95 |
| SLS-6441-10-12-O | 143.95 |
| SLS-6441-12-08-O | 143.95 |
| SLS-6441-12-12-O | 144.00 |
| SLS-6441-16-16-O | 258.15 |
| SLS-6441-20-20-O | 467.60 |
| SLS-6441-24-24-O | 1079.20 |
| SLS-6441-32-32-O | 1725.70 |

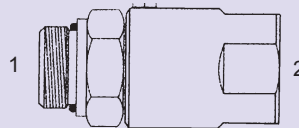

SLS-6448-O - Str.

- (1) Male O-Ring - Stem
- (2) Fem. Pipe - Barrel

| | |
|------------------|--------|
| SLS-6448-06-04-O | 146.40 |
| SLS-6448-08-06-O | 151.55 |
| SLS-6448-08-08-O | 160.40 |
| SLS-6448-10-08-O | 160.40 |
| SLS-6448-16-16-O | 273.45 |
| SLS-6448-20-20-O | 467.60 |

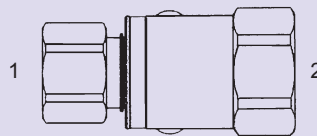

SLS-6455 - Str.

- (1) Fem. O-Ring - Stem
- (2) Fem. O-Ring - Barrel

| | |
|----------------|--------|
| SLS-6455-04-04 | 254.50 |
| SLS-6455-08-08 | 294.75 |
| SLS-6455-16-16 | 465.15 |

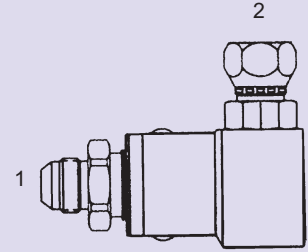

SLS-6513 - 90°

- (1) Male JIC Stem
- (2) Fem. JIC Swivel - Barrel

| | |
|----------------|--------|
| SLS-6513-06-04 | 167.25 |
| SLS-6513-06-06 | 167.25 |
| SLS-6513-08-06 | 189.15 |
| SLS-6513-08-08 | 189.15 |
| SLS-6513-12-12 | 482.10 |
| SLS-6513-16-16 | 547.05 |

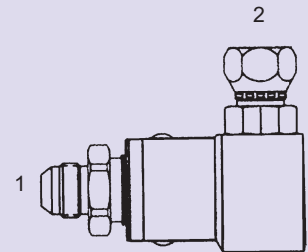

SLS-6513-4K - 90°

4000 PSI

- (1) Male JIC Stem
- (2) Fem. JIC Swivel - Barrel

| | |
|-------------------|---------|
| SLS-6513-4K-08-10 | 189.15 |
| SLS-6513-4K-10-10 | 189.15 |
| SLS-6513-4K-12-12 | 255.90 |
| SLS-6513-4K-16-16 | 312.40 |
| SLS-6513-4K-20-20 | 508.70 |
| SLS-6513-4K-24-24 | 1266.55 |

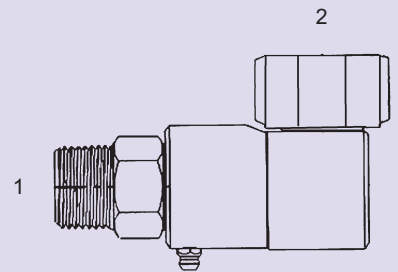

SLS-6573 - 90°

- (1) Male Pipe - Stem
- (2) Fem. 37° Swivel - Barrel

| | |
|----------------|--------|
| SLS-6573-04-04 | 162.15 |
| SLS-6573-04-06 | 162.15 |
| SLS-6573-06-04 | 167.25 |
| SLS-6573-06-06 | 167.25 |
| SLS-6573-08-08 | 169.00 |

STEEL LIVE SWIVELS

Styles may vary from picture

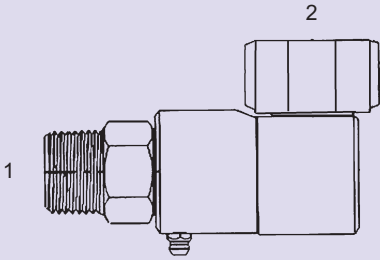

SLS-6573-4K - 90°
4000 PSI
(1) Male Pipe - Stem
(2) Fem. 37° Swivel - Barrel

| | |
|-------------------|---------|
| SLS-6573-4K-08-10 | 169.00 |
| SLS-6573-4K-12-12 | 231.60 |
| SLS-6573-4K-16-16 | 287.70 |
| SLS-6573-4K-20-20 | 471.90 |
| SLS-6573-4K-24-24 | 1102.00 |

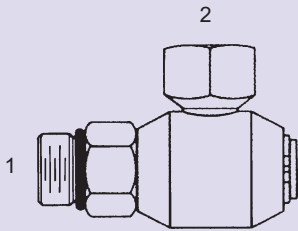

SLS-6805-O - 90°
(1) Male O-Ring - Stem
(2) Fem. Pipe - Barrel

| | |
|------------------|---------|
| SLS-6805-04-04-O | 151.80 |
| SLS-6805-04-06-O | 148.70 |
| SLS-6805-06-04-O | 148.70 |
| SLS-6805-06-06-O | 148.70 |
| SLS-6805-08-06-O | 148.70 |
| SLS-6805-08-08-O | 157.50 |
| SLS-6805-10-08-O | 157.55 |
| SLS-6805-12-12-O | 243.15 |
| SLS-6805-16-16-O | 307.30 |
| SLS-6805-20-20-O | 580.85 |
| SLS-6805-24-24-O | 1183.55 |
| SLS-6805-32-32-O | 1841.40 |

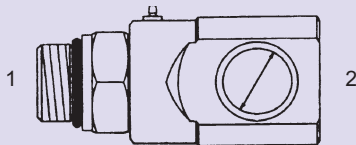

SLS-6805-SB-O - 90°
(1) Male O-Ring - Stem
(2) Fem. Pipe - Barrel
(Short Body)

| | |
|---------------------|---------|
| SLS-6805-SB-04-04-O | 281.75 |
| SLS-6805-SB-06-04-O | 162.15 |
| SLS-6805-SB-06-06-O | 288.60 |
| SLS-6805-SB-08-06-O | 169.00 |
| SLS-6805-SB-08-08-O | 169.00 |
| SLS-6805-SB-12-12-O | 231.55 |
| SLS-6805-SB-16-16-O | 287.70 |
| SLS-6805-SB-20-20-O | 472.00 |
| SLS-6805-SB-24-24-O | 1102.00 |

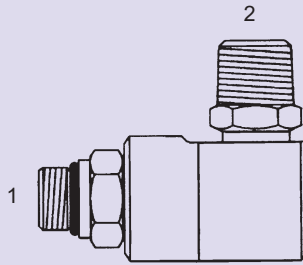

SLS-6806-O - 90°
(1) Male O-Ring - Stem
(2) Male Pipe - Barrel

| | |
|------------------|---------|
| SLS-6806-05-04-O | 148.70 |
| SLS-6806-05-06-O | 148.70 |
| SLS-6806-06-04-O | 148.70 |
| SLS-6806-06-06-O | 148.70 |
| SLS-6806-08-06-O | 148.70 |
| SLS-6806-08-08-O | 157.50 |
| SLS-6806-10-06-O | 189.15 |
| SLS-6806-10-08-O | 157.55 |
| SLS-6806-12-12-O | 243.15 |
| SLS-6806-16-16-O | 307.30 |
| SLS-6806-20-20-O | 508.70 |
| SLS-6806-24-24-O | 1183.60 |
| SLS-6806-32-32-O | 1839.10 |

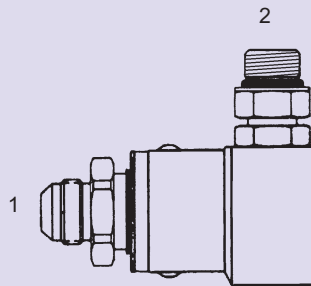

SLS-6814-4K-O - 90°
4000 PSI
(1) Male JIC - Stem
(2) Male O-Ring - Barrel

| | |
|---------------------|--------|
| SLS-6814-4K-12-12-O | 444.90 |
|---------------------|--------|

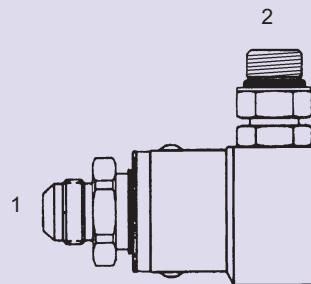

SLS-6814-5K-O - 90°
5000 PSI
(1) Male JIC - Stem
(2) Male O-Ring - Barrel

| | |
|---------------------|--------|
| SLS-6814-5K-04-04-O | 272.85 |
| SLS-6814-5K-08-08-O | 309.50 |

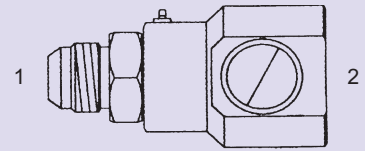

SLS-6815-SB - 90°
(1) Male JIC - Stem
(2) Fem. O-Ring - Barrel
(Short Body)

| | |
|-------------------|--------|
| SLS-6815-SB-06-06 | 162.15 |
| SLS-6815-SB-08-08 | 169.00 |
| SLS-6815-SB-10-08 | 169.00 |
| SLS-6815-SB-12-12 | 231.55 |
| SLS-6815-SB-16-16 | 287.70 |
| SLS-6815-SB-20-20 | 472.00 |

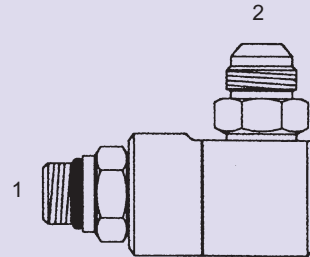

SLS-6841-O - 90°
(1) Male O-Ring - Stem
(2) Male JIC - Barrel

| | |
|------------------|---------|
| SLS-6841-04-04-O | 151.80 |
| SLS-6841-04-06-O | 148.70 |
| SLS-6841-05-04-O | 151.80 |
| SLS-6841-05-05-O | 148.70 |
| SLS-6841-05-06-O | 148.70 |
| SLS-6841-06-05-O | 148.70 |
| SLS-6841-06-06-O | 148.70 |
| SLS-6841-06-08-O | 148.70 |
| SLS-6841-08-05-O | 148.70 |
| SLS-6841-08-06-O | 148.70 |
| SLS-6841-08-08-O | 148.70 |
| SLS-6841-08-10-O | 157.50 |
| SLS-6841-10-06-O | 189.15 |
| SLS-6841-10-08-O | 157.55 |
| SLS-6841-10-10-O | 157.55 |
| SLS-6841-12-12-O | 243.15 |
| SLS-6841-16-16-O | 307.30 |
| SLS-6841-20-20-O | 508.70 |
| SLS-6841-24-24-O | 1183.60 |
| SLS-6841-32-32-O | 1839.10 |

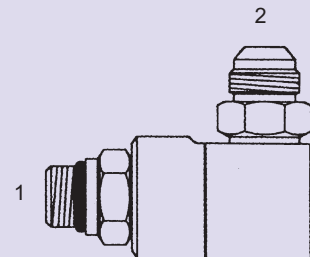

SLS-6841-4K-O - 90°
4000 PSI
(1) Male O-Ring - Stem
(2) Male JIC - Barrel

| | |
|---------------------|--------|
| SLS-6841-4K-12-12-O | 354.10 |
|---------------------|--------|

STEEL LIVE SWIVELS

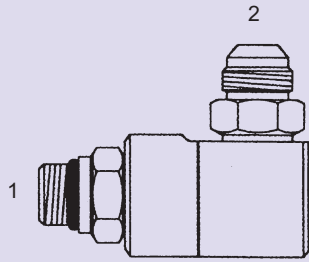

SLS-6841-5K-O - 90°

5000 PSI

- (1) Male O-Ring - Stem
- (2) Male JIC - Barrel

| | |
|---------------------|--------|
| SLS-6841-5K-04-04-O | 276.40 |
| SLS-6841-5K-05-05-O | 260.10 |
| SLS-6841-5K-05-06-O | 260.10 |
| SLS-6841-5K-06-05-O | 260.10 |
| SLS-6841-5K-06-06-O | 260.10 |
| SLS-6841-5K-06-08-O | 260.10 |
| SLS-6841-5K-08-06-O | 260.10 |
| SLS-6841-5K-08-08-O | 260.10 |
| SLS-6841-5K-08-10-O | 276.65 |
| SLS-6841-5K-10-08-O | 276.65 |
| SLS-6841-5K-10-10-O | 276.65 |
| SLS-6841-5K-12-08-O | 276.65 |

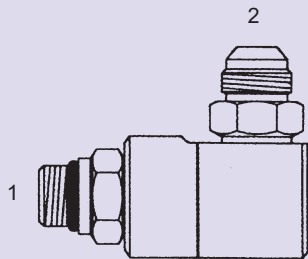

SLS-6841-LH-O - 90°

Large Hex

- (1) Male O-Ring - Stem
- (2) Male JIC - Barrel

| | |
|---------------------|--------|
| SLS-6841-LH-08-08-O | 157.50 |
|---------------------|--------|

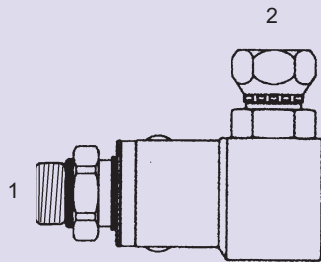

SLS-6843-O - 90°

- (1) Male O-Ring - Stem
- (2) Fem. JIC Swivel - Barrel

| | |
|------------------|--------|
| SLS-6843-06-04-O | 167.25 |
| SLS-6843-06-06-O | 167.25 |
| SLS-6843-08-06-O | 189.15 |
| SLS-6843-08-08-O | 189.15 |

Styles may vary from picture

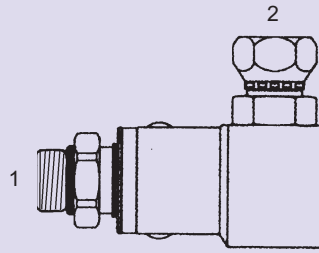

SLS-6843-4K-O - 90°

4000 PSI

- (1) Male O-Ring - Stem
- (2) Fem. JIC Swivel - Barrel

| | |
|---------------------|---------|
| SLS-6843-4K-10-10-O | 189.15 |
| SLS-6843-4K-12-12-O | 255.90 |
| SLS-6843-4K-16-16-O | 312.40 |
| SLS-6843-4K-20-20-O | 508.70 |
| SLS-6843-4K-24-24-O | 1266.55 |

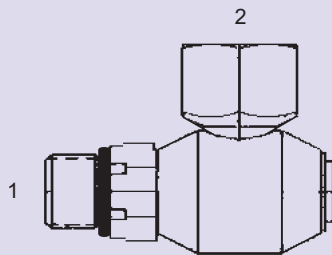

SLS-6845-O - 90°

- (1) Male O-Ring - Stem
- (2) Fem. O-Ring - Barrel

| | |
|------------------|--------|
| SLS-6845-08-08-O | 148.70 |
|------------------|--------|

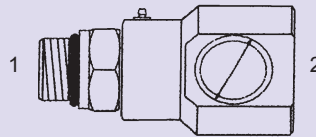

SLS-6845-SB-O - 90°

- (1) Male O-Ring - Stem
- (2) Fem. O-Ring - Barrel
(Short Body)

| | |
|---------------------|--------|
| SLS-6845-SB-04-04-O | 275.90 |
| SLS-6845-SB-06-06-O | 162.15 |
| SLS-6845-SB-08-08-O | 169.00 |
| SLS-6845-SB-10-08-O | 169.00 |
| SLS-6845-SB-12-12-O | 231.55 |
| SLS-6845-SB-16-16-O | 287.70 |
| SLS-6845-SB-20-20-O | 472.00 |

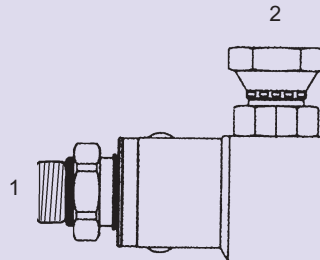

SLS-6849-O - 90°

- (1) Male O-Ring - Stem
- (2) Fem. Pipe Swivel - Barrel

| | |
|------------------|--------|
| SLS-6849-12-12-O | 444.80 |
| SLS-6849-16-16-O | 542.95 |

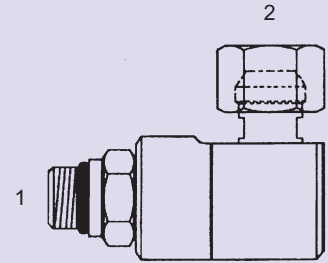

SLS-6901-O - 90°

- (1) Male O-Ring - Stem
- (2) Fem. Pipe Swivel - Barrel

| | |
|------------------|---------|
| SLS-6901-04-04-O | 151.80 |
| SLS-6901-04-06-O | 148.70 |
| SLS-6901-05-04-O | 151.80 |
| SLS-6901-06-04-O | 148.70 |
| SLS-6901-06-06-O | 148.70 |
| SLS-6901-08-06-O | 148.70 |
| SLS-6901-08-08-O | 157.50 |
| SLS-6901-10-08-O | 157.55 |
| SLS-6901-12-12-O | 243.15 |
| SLS-6901-16-16-O | 307.30 |
| SLS-6901-20-20-O | 508.70 |
| SLS-6901-24-24-O | 1183.60 |
| SLS-6901-32-32-O | 1839.10 |

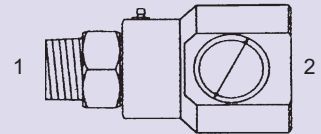

SLS-6975-SB - 90°

- (1) Male Pipe - Stem
- (2) Fem. O-Ring - Barrel
(Short Body)

| | |
|-------------------|--------|
| SLS-6975-SB-04-04 | 276.30 |
| SLS-6975-SB-04-06 | 162.15 |
| SLS-6975-SB-06-06 | 162.15 |
| SLS-6975-SB-06-08 | 169.00 |
| SLS-6975-SB-08-08 | 169.00 |
| SLS-6975-SB-12-12 | 231.55 |
| SLS-6975-SB-16-16 | 287.70 |
| SLS-6975-SB-20-20 | 472.00 |

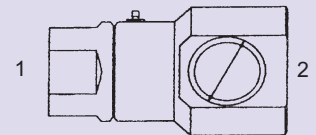

SLS-6985-SB - 90°

- (1) Fem. Pipe - Stem
- (2) Fem. O-Ring - Barrel

| | |
|-------------------|--------|
| SLS-6985-SB-04-06 | 162.15 |
| SLS-6985-SB-06-06 | 169.00 |
| SLS-6985-SB-06-08 | 169.00 |
| SLS-6985-SB-08-08 | 169.00 |
| SLS-6985-SB-12-12 | 231.55 |
| SLS-6985-SB-16-16 | 287.70 |
| SLS-6985-SB-20-20 | 472.00 |

STEEL LIVE SWIVELS - DUAL PLANE (90°)

Styles may vary from picture

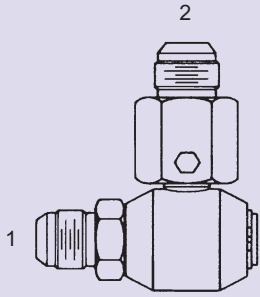

SLS-DP-2500 - 90°

- (1) Male JIC - Stem
- (2) Male JIC - Barrel

| | |
|-------------------|---------|
| SLS-DP-2500-05-06 | 248.75 |
| SLS-DP-2500-06-06 | 248.75 |
| SLS-DP-2500-08-06 | 248.75 |
| SLS-DP-2500-08-08 | 248.75 |
| SLS-DP-2500-10-10 | 330.30 |
| SLS-DP-2500-12-12 | 384.60 |
| SLS-DP-2500-16-16 | 600.10 |
| SLS-DP-2500-20-20 | 1095.85 |
| SLS-DP-2500-24-24 | 2077.00 |

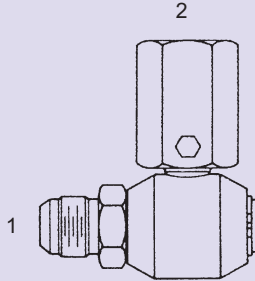

SLS-DP-2502 - 90°

- (1) Male JIC - Stem
- (2) Fem. Pipe - Barrel

| | |
|-------------------|---------|
| SLS-DP-2502-05-04 | 248.75 |
| SLS-DP-2502-05-06 | 248.75 |
| SLS-DP-2502-06-04 | 248.75 |
| SLS-DP-2502-06-06 | 248.75 |
| SLS-DP-2502-08-06 | 248.75 |
| SLS-DP-2502-10-08 | 330.30 |
| SLS-DP-2502-12-12 | 384.60 |
| SLS-DP-2502-16-16 | 600.10 |
| SLS-DP-2502-20-20 | 1095.85 |
| SLS-DP-2502-24-24 | 2077.00 |

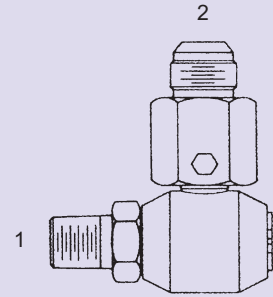

SLS-DP-2571-4K - 90°

4000 PSI

- (1) Male Pipe - Stem
- (2) Male JIC - Barrel

| | |
|----------------------|---------|
| SLS-DP-2571-4K-12-12 | 456.85 |
| SLS-DP-2571-4K-16-16 | 585.85 |
| SLS-DP-2571-4K-20-20 | 894.85 |
| SLS-DP-2571-4K-24-24 | 2368.55 |

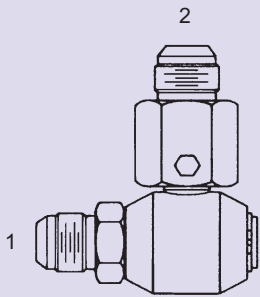

SLS-DP-2500-4K - 90°

4000 PSI

- (1) Male JIC - Stem
- (2) Male JIC - Barrel

| | |
|----------------------|---------|
| SLS-DP-2500-4K-12-12 | 432.45 |
| SLS-DP-2500-4K-16-16 | 561.25 |
| SLS-DP-2500-4K-20-20 | 939.60 |
| SLS-DP-2500-4K-24-24 | 2204.00 |

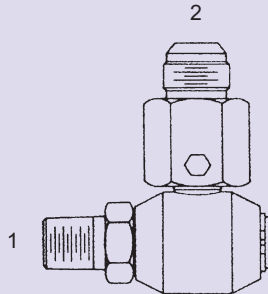

SLS-DP-2571 - 90°

- (1) Male Pipe - Stem
- (2) Male JIC - Barrel

| | |
|-------------------|---------|
| SLS-DP-2571-04-06 | 248.75 |
| SLS-DP-2571-06-08 | 248.75 |
| SLS-DP-2571-08-08 | 330.30 |
| SLS-DP-2571-08-10 | 330.30 |
| SLS-DP-2571-12-12 | 384.60 |
| SLS-DP-2571-16-16 | 600.10 |
| SLS-DP-2571-20-20 | 1095.85 |
| SLS-DP-2571-24-24 | 2077.00 |

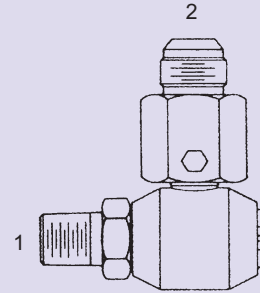

SLS-DP-2571-5K - 90°

5000 PSI

- (1) Male Pipe - Stem
- (2) Male JIC - Barrel

| | |
|----------------------|--------|
| SLS-DP-2571-5K-04-04 | 293.85 |
| SLS-DP-2571-5K-06-06 | 313.60 |
| SLS-DP-2571-5K-08-08 | 349.45 |
| SLS-DP-2571-5K-08-10 | 349.45 |

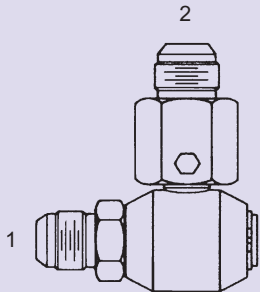

SLS-DP-2500-5K - 90°

5000 PSI

- (1) Male JIC - Stem
- (2) Male JIC - Barrel

| | |
|----------------------|--------|
| SLS-DP-2500-5K-04-04 | 308.55 |
| SLS-DP-2500-5K-06-06 | 308.55 |
| SLS-DP-2500-5K-08-08 | 329.40 |
| SLS-DP-2500-5K-10-10 | 329.40 |

STEEL LIVE SWIVELS - DUAL PLANE (90°)

Styles may vary from picture

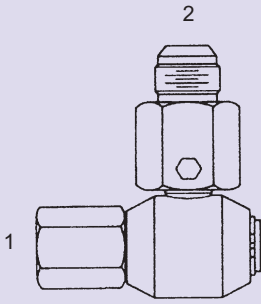

SLS-DP-2581 - 90°

- (1) Fem. Pipe - Stem
- (2) Male JIC - Barrel

| | |
|-------------------|---------|
| SLS-DP-2581-04-06 | 248.75 |
| SLS-DP-2581-06-06 | 248.75 |
| SLS-DP-2581-06-08 | 248.75 |
| SLS-DP-2581-08-10 | 330.30 |
| SLS-DP-2581-12-12 | 384.60 |
| SLS-DP-2581-16-16 | 600.10 |
| SLS-DP-2581-20-20 | 1095.85 |
| SLS-DP-2581-24-24 | 2077.00 |

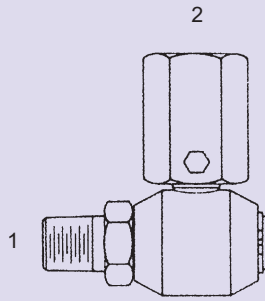

SLS-DP-5502-5K - 90°

5000 PSI

- (1) Male Pipe - Stem
- (2) Fem. Pipe - Barrel

| | |
|----------------------|--------|
| SLS-DP-5502-5K-04-04 | 308.55 |
| SLS-DP-5502-5K-06-06 | 320.55 |
| SLS-DP-5502-5K-08-08 | 329.40 |

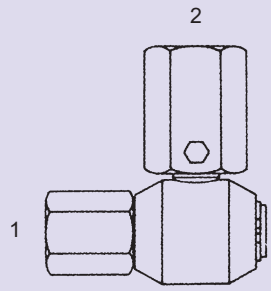

SLS-DP-5504-5K - 90°

5000 PSI

- (1) Fem. Pipe - Stem
- (2) Fem. Pipe - Barrel

| | |
|----------------------|--------|
| SLS-DP-5504-5K-04-04 | 308.55 |
| SLS-DP-5504-5K-06-06 | 320.55 |
| SLS-DP-5504-5K-08-08 | 313.70 |

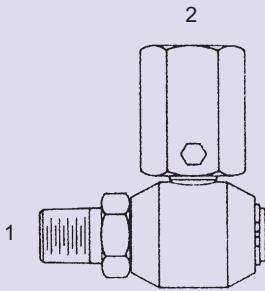

SLS-DP-5502 - 90°

- (1) Male Pipe - Stem
- (2) Fem. Pipe - Barrel

| | |
|-------------------|---------|
| SLS-DP-5502-04-04 | 248.75 |
| SLS-DP-5502-04-06 | 248.75 |
| SLS-DP-5502-06-06 | 248.75 |
| SLS-DP-5502-08-08 | 330.30 |
| SLS-DP-5502-12-12 | 384.60 |
| SLS-DP-5502-16-16 | 600.10 |
| SLS-DP-5502-20-20 | 1095.85 |
| SLS-DP-5502-24-24 | 2077.00 |

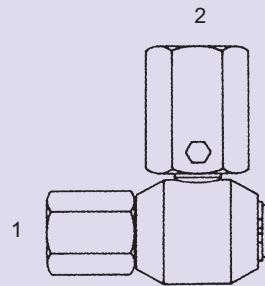

SLS-DP-5504 - 90°

- (1) Fem. Pipe - Stem
- (2) Fem. Pipe - Barrel

| | |
|-------------------|---------|
| SLS-DP-5504-04-04 | 248.75 |
| SLS-DP-5504-04-06 | 248.75 |
| SLS-DP-5504-06-04 | 248.75 |
| SLS-DP-5504-06-06 | 248.75 |
| SLS-DP-5504-08-08 | 330.30 |
| SLS-DP-5504-12-12 | 384.60 |
| SLS-DP-5504-16-16 | 600.10 |
| SLS-DP-5504-20-20 | 1095.85 |
| SLS-DP-5504-24-24 | 2077.00 |

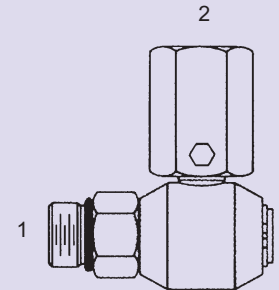

SLS-DP-6805-O - 90°

- (1) Male O-Ring - Stem
- (2) Fem. Pipe - Barrel

| | |
|---------------------|---------|
| SLS-DP-6805-06-04-O | 248.75 |
| SLS-DP-6805-06-06-O | 248.75 |
| SLS-DP-6805-08-06-O | 248.75 |
| SLS-DP-6805-10-08-O | 330.30 |
| SLS-DP-6805-12-12-O | 384.60 |
| SLS-DP-6805-16-16-O | 600.10 |
| SLS-DP-6805-20-20-O | 1095.85 |
| SLS-DP-6805-24-24-O | 2077.00 |

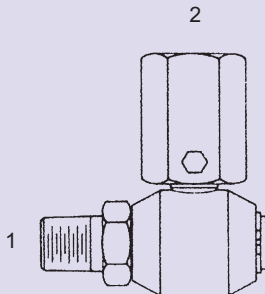

SLS-DP-5502-4K - 90°

4000 PSI

- (1) Male Pipe - Stem
- (2) Fem. Pipe - Barrel

| | |
|----------------------|---------|
| SLS-DP-5502-4K-12-12 | 411.75 |
| SLS-DP-5502-4K-16-16 | 561.25 |
| SLS-DP-5502-4K-20-20 | 939.60 |
| SLS-DP-5502-4K-24-24 | 2204.00 |

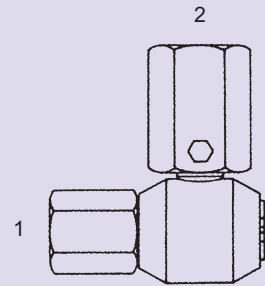

SLS-DP-5504-4K - 90°

4000 PSI

- (1) Fem. Pipe - Stem
- (2) Fem. Pipe - Barrel

| | |
|----------------------|---------|
| SLS-DP-5504-4K-12-12 | 432.45 |
| SLS-DP-5504-4K-16-16 | 561.25 |
| SLS-DP-5504-4K-20-20 | 939.60 |
| SLS-DP-5504-4K-24-24 | 2204.00 |

STEEL LIVE SWIVELS - DUAL PLANE (90°)

Styles may vary from picture

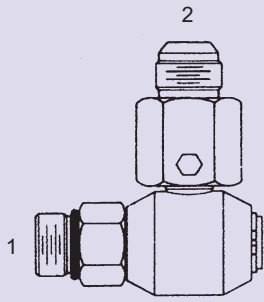

SLS-DP-6841-O - 90°

- (1) Male O-Ring - Stem
- (2) Male JIC - Barrel

| | |
|---------------------|---------|
| SLS-DP-6841-06-06-O | 248.75 |
| SLS-DP-6841-08-06-O | 248.75 |
| SLS-DP-6841-08-08-O | 248.75 |
| SLS-DP-6841-10-10-O | 330.30 |
| SLS-DP-6841-12-12-O | 384.60 |
| SLS-DP-6841-16-16-O | 600.10 |
| SLS-DP-6841-20-20-O | 1095.85 |
| SLS-DP-6841-24-24-O | 2077.00 |

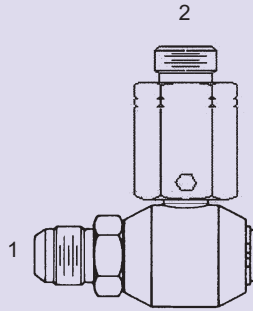

SLS-DP-OFS-6816 - 90°

- (1) Male JIC - Stem
- (2) Male O-Ring Face Seal - Barrel

| | |
|-----------------------|---------|
| SLS-DP-OFS-6816-06-06 | 292.60 |
| SLS-DP-OFS-6816-08-08 | 292.60 |
| SLS-DP-OFS-6816-10-10 | 388.60 |
| SLS-DP-OFS-6816-12-12 | 452.50 |
| SLS-DP-OFS-6816-16-16 | 705.90 |
| SLS-DP-OFS-6816-20-20 | 1289.20 |
| SLS-DP-OFS-6816-24-24 | 2443.55 |

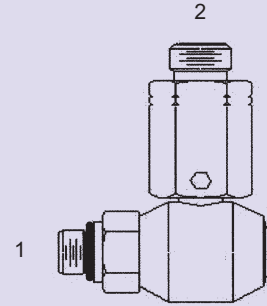

SLS-DP-OFS-6846-4K-O - 90°

4000 PSI

- (1) Male O-Ring - Stem
- (2) Male O-Ring Face Seal - Barrel

| | |
|--------------------------|---------|
| SLS-DP-OFS-6846-4K-12-12 | 432.45 |
| SLS-DP-OFS-6846-4K-16-16 | 534.45 |
| SLS-DP-OFS-6846-4K-20-20 | 939.60 |
| SLS-DP-OFS-6846-4K-24-24 | 2204.00 |

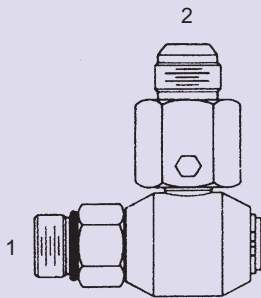

SLS-DP-6841-4K-O - 90°

4000 PSI

- (1) Male O-Ring - Stem
- (2) Male JIC - Barrel

| | |
|------------------------|---------|
| SLS-DP-6841-4K-12-12-O | 432.45 |
| SLS-DP-6841-4K-16-16-O | 561.25 |
| SLS-DP-6841-4K-20-20-O | 939.60 |
| SLS-DP-6841-4K-24-24-O | 2204.00 |

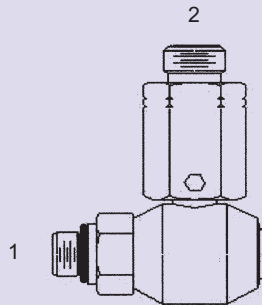

SLS-DP-OFS-6846-O - 90°

- (1) Male O-Ring - Stem
- (2) Male O-Ring Face Seal - Barrel

| | |
|-------------------------|---------|
| SLS-DP-OFS-6846-06-06-O | 292.60 |
| SLS-DP-OFS-6846-08-08-O | 292.60 |
| SLS-DP-OFS-6846-10-10-O | 388.60 |
| SLS-DP-OFS-6846-12-12-O | 452.50 |
| SLS-DP-OFS-6846-16-16-O | 705.90 |
| SLS-DP-OFS-6846-20-20-O | 1289.20 |
| SLS-DP-OFS-6846-24-24-O | 2443.55 |

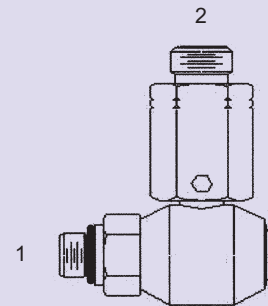

SLS-DP-OFS-6846-5K-O - 90°

5000 PSI

- (1) Male O-Ring - Stem
- (2) Male O-Ring Face Seal - Barrel

| | |
|--------------------------|--------|
| SLS-DP-OFS-6846-5K-06-06 | 308.55 |
| SLS-DP-OFS-6846-5K-08-08 | 329.40 |
| SLS-DP-OFS-6846-5K-10-10 | 329.40 |

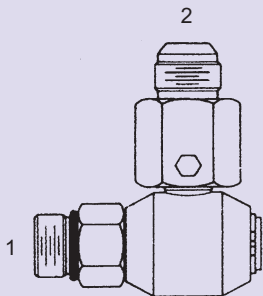

SLS-DP-6841-5K-O - 90°

5000 PSI

- (1) Male O-Ring - Stem
- (2) Male JIC - Barrel

| | |
|------------------------|--------|
| SLS-DP-6841-5K-04-04-O | 308.55 |
| SLS-DP-6841-5K-06-06-O | 308.55 |
| SLS-DP-6841-5K-08-08-O | 329.40 |
| SLS-DP-6841-5K-10-10-O | 329.40 |

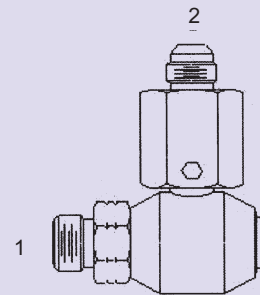

SLS-DP-OFS-6861 - 90°

- (1) Male O-Ring Face Seal - Stem
- (2) Male JIC - Barrel

| | |
|-----------------------|---------|
| SLS-DP-OFS-6861-06-06 | 292.60 |
| SLS-DP-OFS-6861-08-08 | 292.60 |
| SLS-DP-OFS-6861-10-10 | 388.60 |
| SLS-DP-OFS-6861-12-12 | 452.50 |
| SLS-DP-OFS-6861-16-16 | 705.90 |
| SLS-DP-OFS-6861-20-20 | 1289.20 |
| SLS-DP-OFS-6861-24-24 | 2443.55 |

STEEL LIVE SWIVELS - DUAL PLANE (90°)

Styles may vary from picture

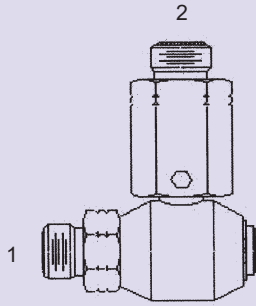

SLS-DP-OFS-6866 - 90°

- (1) Male O-Ring Face Seal - Stem
- (2) Male O-Ring Face Seal - Barrel

| | |
|-----------------------|---------|
| SLS-DP-OFS-6866-06-06 | 292.60 |
| SLS-DP-OFS-6866-08-08 | 292.60 |
| SLS-DP-OFS-6866-10-10 | 388.60 |
| SLS-DP-OFS-6866-12-12 | 683.25 |
| SLS-DP-OFS-6866-16-16 | 705.90 |
| SLS-DP-OFS-6866-20-20 | 1289.20 |
| SLS-DP-OFS-6866-24-24 | 2443.55 |

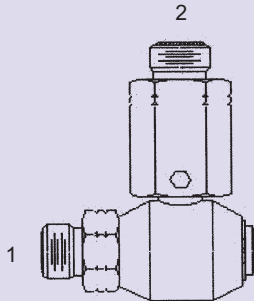

SLS-DP-OFS-6866-4K - 90°

- 4000 PSI
- (1) Male O-Ring Face Seal - Stem
- (2) Male O-Ring Face Seal - Barrel

| | |
|--------------------------|---------|
| SLS-DP-OFS-6866-4K-12-12 | 432.45 |
| SLS-DP-OFS-6866-4K-16-16 | 534.45 |
| SLS-DP-OFS-6866-4K-20-20 | 939.60 |
| SLS-DP-OFS-6866-4K-24-24 | 2204.00 |

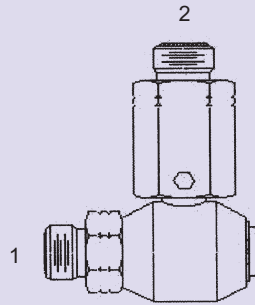

SLS-DP-OFS-6866-5K - 90°

- 5000 PSI
- (1) Male O-Ring Face Seal - Stem
- (2) Male O-Ring Face Seal - Barrel

| | |
|--------------------------|--------|
| SLS-DP-OFS-6866-5K-06-06 | 308.55 |
| SLS-DP-OFS-6866-5K-10-10 | 329.40 |

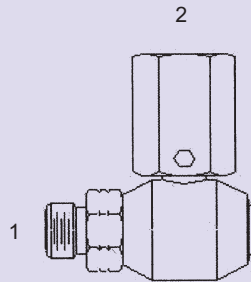

SLS-DP-OFS-6868 - 90°

- (1) Male O-Ring Face Seal - Stem
- (2) Female Pipe - Barrel

| | |
|-----------------------|---------|
| SLS-DP-OFS-6868-06-04 | 292.60 |
| SLS-DP-OFS-6868-08-06 | 292.60 |
| SLS-DP-OFS-6868-10-08 | 388.60 |
| SLS-DP-OFS-6868-12-12 | 452.50 |
| SLS-DP-OFS-6868-16-16 | 705.90 |
| SLS-DP-OFS-6868-20-20 | 1289.20 |
| SLS-DP-OFS-6868-24-24 | 2443.55 |

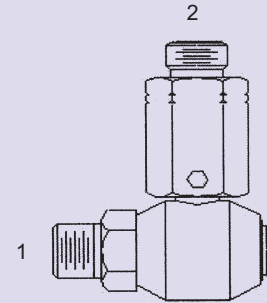

SLS-DP-OFS-6876 - 90°

- (1) Male Pipe - Stem
- (2) Male O-Ring Face Seal - Barrel

| | |
|-----------------------|---------|
| SLS-DP-OFS-6876-04-06 | 292.60 |
| SLS-DP-OFS-6876-06-08 | 292.60 |
| SLS-DP-OFS-6876-08-10 | 388.60 |
| SLS-DP-OFS-6876-12-12 | 452.50 |
| SLS-DP-OFS-6876-16-16 | 705.90 |
| SLS-DP-OFS-6876-20-20 | 1289.20 |
| SLS-DP-OFS-6876-24-24 | 2443.55 |

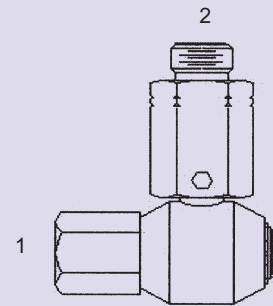

SLS-DP-OFS-6886 - 90°

- (1) Female Pipe - Stem
- (2) Male O-Ring Face Seal - Barrel

| | |
|-----------------------|---------|
| SLS-DP-OFS-6886-04-06 | 292.60 |
| SLS-DP-OFS-6886-06-08 | 292.60 |
| SLS-DP-OFS-6886-08-10 | 388.60 |
| SLS-DP-OFS-6886-12-12 | 452.50 |
| SLS-DP-OFS-6886-16-16 | 705.90 |
| SLS-DP-OFS-6886-20-20 | 1289.20 |
| SLS-DP-OFS-6886-24-24 | 2443.55 |

STEEL LIVE SWIVELS - O-RING FACE SEAL

Styles may vary from picture

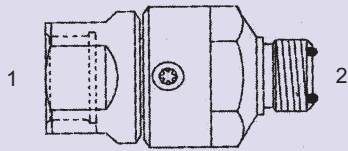

SLS-OFS-2406 - Str.

- (1) Fem. O-Ring Face Seal - Stem
- (2) Male O-Ring Face Seal - Barrel

| | |
|--------------------|---------|
| SLS-OFS-2406-06-06 | 167.25 |
| SLS-OFS-2406-08-08 | 189.15 |
| SLS-OFS-2406-10-10 | 189.15 |
| SLS-OFS-2406-12-12 | 255.90 |
| SLS-OFS-2406-16-16 | 312.40 |
| SLS-OFS-2406-20-20 | 508.60 |
| SLS-OFS-2406-24-24 | 1266.55 |

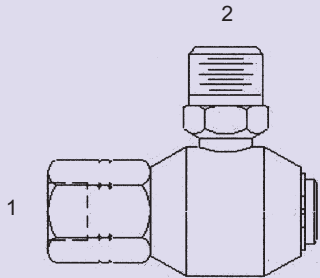

SLS-OFS-2507 - 90°

- (1) Fem. O-Ring Face Seal - Stem
- (2) Male Pipe - Barrel

| | |
|--------------------|---------|
| SLS-OFS-2507-04-04 | 178.60 |
| SLS-OFS-2507-06-04 | 174.90 |
| SLS-OFS-2507-06-06 | 174.90 |
| SLS-OFS-2507-08-04 | 174.90 |
| SLS-OFS-2507-08-06 | 174.90 |
| SLS-OFS-2507-08-08 | 185.30 |
| SLS-OFS-2507-10-08 | 185.30 |
| SLS-OFS-2507-12-12 | 286.10 |
| SLS-OFS-2507-16-16 | 361.55 |
| SLS-OFS-2507-20-20 | 683.35 |
| SLS-OFS-2507-24-24 | 1392.45 |

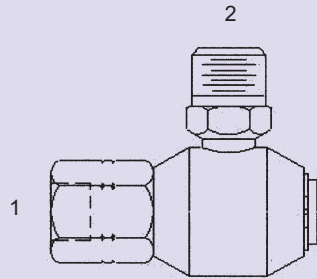

SLS-OFS-2509 - 90°

- (1) Fem. Pipe Swivel - Stem
- (2) Fem. O-Ring Face Seal - Barrel

| | |
|--------------------|---------|
| SLS-OFS-2509-04-04 | 178.60 |
| SLS-OFS-2509-06-04 | 174.90 |
| SLS-OFS-2509-06-06 | 174.90 |
| SLS-OFS-2509-08-04 | 174.90 |
| SLS-OFS-2509-08-06 | 174.90 |
| SLS-OFS-2509-08-08 | 185.30 |
| SLS-OFS-2509-10-08 | 185.30 |
| SLS-OFS-2509-12-12 | 286.10 |
| SLS-OFS-2509-16-16 | 361.55 |
| SLS-OFS-2509-20-20 | 683.35 |
| SLS-OFS-2509-24-24 | 1392.45 |

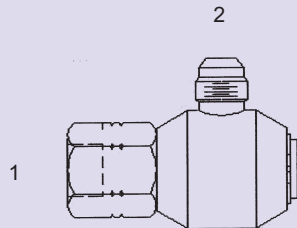

SLS-OFS-2510 - 90°

- (1) Fem. O-Ring Face Seal - Stem
- (2) Male JIC - Barrel

| | |
|--------------------|---------|
| SLS-OFS-2510-04-04 | 178.60 |
| SLS-OFS-2510-04-05 | 178.60 |
| SLS-OFS-2510-06-05 | 174.90 |
| SLS-OFS-2510-06-06 | 174.90 |
| SLS-OFS-2510-06-08 | 174.90 |
| SLS-OFS-2510-08-05 | 174.90 |
| SLS-OFS-2510-08-06 | 174.90 |
| SLS-OFS-2510-08-08 | 174.90 |
| SLS-OFS-2510-08-10 | 185.30 |
| SLS-OFS-2510-10-08 | 185.30 |
| SLS-OFS-2510-10-10 | 185.30 |
| SLS-OFS-2510-12-12 | 286.10 |
| SLS-OFS-2510-16-16 | 361.55 |
| SLS-OFS-2510-20-20 | 683.35 |
| SLS-OFS-2510-24-24 | 1392.45 |

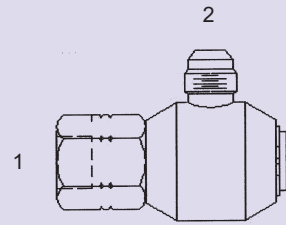

SLS-OFS-2510-5K - 90°
5000 PSI

- (1) Fem. O-Ring Face Seal - Stem
- (2) Male JIC - Barrel

| | |
|-----------------------|--------|
| SLS-OFS-2510-5K-04-05 | 260.10 |
| SLS-OFS-2510-5K-04-06 | 260.10 |
| SLS-OFS-2510-5K-06-05 | 260.10 |
| SLS-OFS-2510-5K-06-06 | 260.10 |
| SLS-OFS-2510-5K-06-08 | 260.10 |
| SLS-OFS-2510-5K-08-06 | 260.10 |
| SLS-OFS-2510-5K-08-08 | 260.10 |
| SLS-OFS-2510-5K-08-10 | 276.65 |
| SLS-OFS-2510-5K-10-08 | 276.65 |
| SLS-OFS-2510-5K-10-10 | 276.65 |

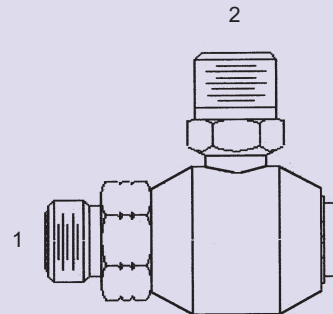

SLS-OFS-2567 - 90°

- (1) Male O-Ring Face Seal - Stem
- (2) Male Pipe - Barrel

| | |
|--------------------|---------|
| SLS-OFS-2567-06-04 | 174.90 |
| SLS-OFS-2567-06-06 | 174.90 |
| SLS-OFS-2567-08-04 | 174.90 |
| SLS-OFS-2567-08-06 | 174.90 |
| SLS-OFS-2567-08-08 | 185.30 |
| SLS-OFS-2567-10-08 | 185.30 |
| SLS-OFS-2567-12-12 | 286.10 |
| SLS-OFS-2567-16-16 | 361.55 |
| SLS-OFS-2567-20-20 | 683.35 |
| SLS-OFS-2567-24-24 | 1392.45 |

STEEL LIVE SWIVELS - O-RING FACE SEAL

Styles may vary from picture

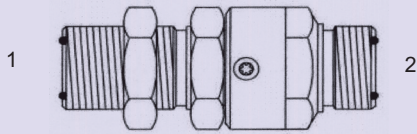

SLS-OFS-2700-LN - Str.

- (1) Male O-Ring Face Seal Bulkhead w/Locknut - Stem
- (2) Male O-Ring Face Seal - Barrel

| | |
|-----------------------|--------|
| SLS-OFS-2700-LN-06-06 | 190.00 |
| SLS-OFS-2700-LN-08-08 | 214.90 |
| SLS-OFS-2700-LN-10-10 | 214.90 |
| SLS-OFS-2700-LN-12-12 | 276.30 |
| SLS-OFS-2700-LN-16-16 | 354.90 |
| SLS-OFS-2700-LN-20-20 | 566.75 |

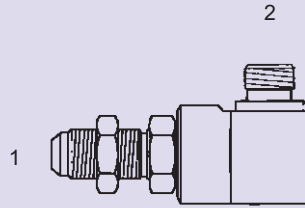

SLS-OFS-2716-LN-4K - 90°

4000 PSI

- (1) Male JIC - Stem
- (2) O-Ring Face Seal - Barrel

| | |
|--------------------------|--------|
| SLS-OFS-2716-LN-4K-12-12 | 255.90 |
| SLS-OFS-2716-LN-4K-16-16 | 312.40 |
| SLS-OFS-2716-LN-4K-20-20 | 508.60 |

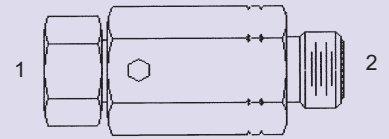

SLS-OFS-6426 - Str.

- (1) Fem. JIC - Stem
- (2) Male O-Ring Face Seal - Barrel

| | |
|--------------------|---------|
| SLS-OFS-6426-06-06 | 145.40 |
| SLS-OFS-6426-08-08 | 145.40 |
| SLS-OFS-6426-10-10 | 169.40 |
| SLS-OFS-6426-12-12 | 169.40 |
| SLS-OFS-6426-16-16 | 303.70 |
| SLS-OFS-6426-20-20 | 566.40 |
| SLS-OFS-6426-24-24 | 1269.65 |

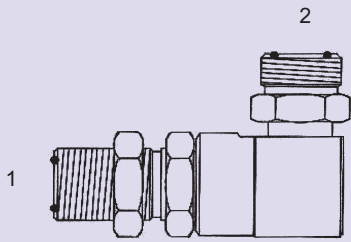

SLS-OFS-2701-LN-4K - 90°

4000 PSI

- (1) Male O-Ring Face Seal Bulkhead w/ Locknut - Stem
- (2) Male O-Ring Face Seal - Barrel

| | |
|--------------------------|--------|
| SLS-OFS-2701-LN-4K-12-12 | 276.30 |
| SLS-OFS-2701-LN-4K-16-16 | 354.90 |
| SLS-OFS-2701-LN-4K-20-20 | 566.75 |

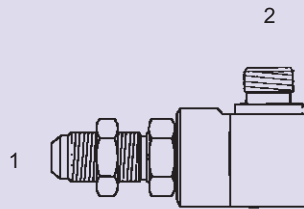

SLS-OFS-2716-LN-5K - 90°

5000 PSI

- (1) Male JIC - Stem
- (2) O-Ring Face Seal - Barrel

| | |
|--------------------------|--------|
| SLS-OFS-2716-LN-5K-08-06 | 189.15 |
| SLS-OFS-2716-LN-5K-08-08 | 189.15 |
| SLS-OFS-2716-LN-5K-08-10 | 189.15 |
| SLS-OFS-2716-LN-5K-10-06 | 189.15 |
| SLS-OFS-2716-LN-5K-10-08 | 189.15 |
| SLS-OFS-2716-LN-5K-10-10 | 189.15 |

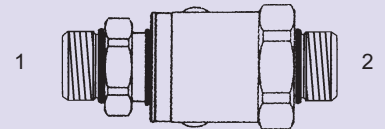

SLS-OFS-6446-O - Str.

- (1) Male O-Ring - Stem
- (2) Male O-Ring Face Seal - Barrel

| | |
|----------------------|---------|
| SLS-OFS-6446-06-06-O | 145.40 |
| SLS-OFS-6446-08-06-O | 145.40 |
| SLS-OFS-6446-08-10-O | 169.40 |
| SLS-OFS-6446-10-10-O | 169.40 |
| SLS-OFS-6446-12-12-O | 169.40 |
| SLS-OFS-6446-16-16-O | 303.70 |
| SLS-OFS-6446-20-20-O | 566.40 |
| SLS-OFS-6446-24-24-O | 1269.65 |

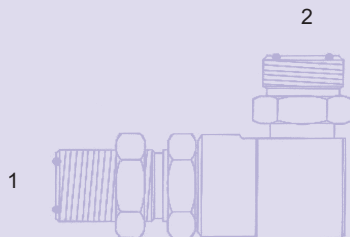

SLS-OFS-2701-LN-5K - 90°.

5000 PSI

- (1) Male O-Ring Face Seal Bulkhead w/ Locknut - Stem
- (2) Male O-Ring Face Seal - Barrel

| | |
|--------------------------|--------|
| SLS-OFS-2701-LN-5K-06-06 | 190.00 |
| SLS-OFS-2701-LN-5K-08-08 | 214.90 |
| SLS-OFS-2701-LN-5K-10-10 | 214.90 |

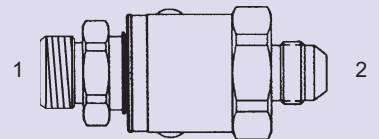

SLS-OFS-6461 - Str.

- (1) Male O-Ring Face Seal - Stem
- (2) Male JIC - Barrel

| | |
|--------------------|---------|
| SLS-OFS-6461-06-06 | 145.40 |
| SLS-OFS-6461-08-08 | 145.40 |
| SLS-OFS-6461-12-12 | 169.40 |
| SLS-OFS-6461-16-16 | 303.70 |
| SLS-OFS-6461-20-20 | 566.40 |
| SLS-OFS-6461-24-24 | 1269.65 |

STEEL LIVE SWIVELS - O-RING FACE SEAL

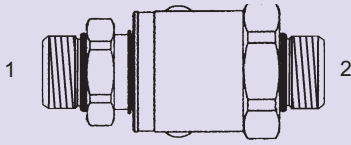

SLS-OFS-6466 - Str.

- (1) Male O-Ring Face Seal - Stem
- (2) Male O-Ring Face Seal - Barrel

| | |
|--------------------|---------|
| SLS-OFS-6466-06-06 | 145.40 |
| SLS-OFS-6466-08-08 | 145.40 |
| SLS-OFS-6466-10-10 | 169.40 |
| SLS-OFS-6466-12-12 | 169.40 |
| SLS-OFS-6466-16-16 | 303.70 |
| SLS-OFS-6466-20-20 | 566.45 |
| SLS-OFS-6466-24-24 | 1269.65 |

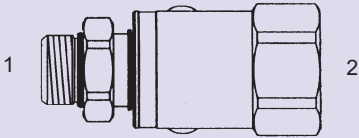

SLS-OFS-6468 - Str.

- (1) Male O-Ring Face Seal - Stem
- (2) Fem. Pipe - Barrel

| | |
|--------------------|---------|
| SLS-OFS-6468-06-04 | 145.40 |
| SLS-OFS-6468-08-06 | 145.40 |
| SLS-OFS-6468-10-08 | 169.40 |
| SLS-OFS-6468-12-12 | 169.40 |
| SLS-OFS-6468-16-16 | 303.70 |
| SLS-OFS-6468-20-20 | 566.40 |
| SLS-OFS-6468-24-24 | 1269.65 |

Styles may vary from picture

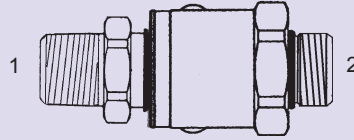

SLS-OFS-6476 - Str.

- (1) Male Pipe - Stem
- (2) Male O-Ring Face Seal - Barrel

| | |
|--------------------|---------|
| SLS-OFS-6476-04-06 | 145.40 |
| SLS-OFS-6476-06-08 | 145.40 |
| SLS-OFS-6476-12-12 | 169.40 |
| SLS-OFS-6476-16-16 | 303.70 |
| SLS-OFS-6476-20-20 | 566.40 |
| SLS-OFS-6476-24-24 | 1269.65 |

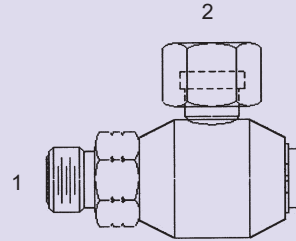

SLS-OFS-6500 - 90°

- (1) Male O-Ring Face Seal - Stem
- (2) Fem. O-Ring Face Seal Swivel - Barrel

| | |
|--------------------|---------|
| SLS-OFS-6500-06-06 | 174.90 |
| SLS-OFS-6500-08-06 | 174.90 |
| SLS-OFS-6500-08-08 | 185.30 |
| SLS-OFS-6500-08-10 | 185.30 |
| SLS-OFS-6500-10-08 | 185.30 |
| SLS-OFS-6500-10-10 | 185.30 |
| SLS-OFS-6500-12-12 | 286.10 |
| SLS-OFS-6500-16-16 | 361.55 |
| SLS-OFS-6500-20-20 | 683.35 |
| SLS-OFS-6500-24-24 | 1392.45 |

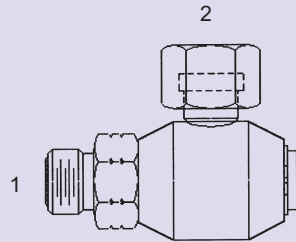

SLS-OFS-6500-5K - 90°

5000 PSI

- (1) Male O-Ring Face Seal - Stem
- (2) Fem. O-Ring Face Seal Swivel - Barrel

| | |
|-----------------------|--------|
| SLS-OFS-6500-5K-04-06 | 260.10 |
| SLS-OFS-6500-5K-06-06 | 260.10 |
| SLS-OFS-6500-5K-06-08 | 260.10 |
| SLS-OFS-6500-5K-08-06 | 260.10 |
| SLS-OFS-6500-5K-08-08 | 260.10 |
| SLS-OFS-6500-5K-08-10 | 276.65 |
| SLS-OFS-6500-5K-10-08 | 276.65 |
| SLS-OFS-6500-5K-10-10 | 276.65 |

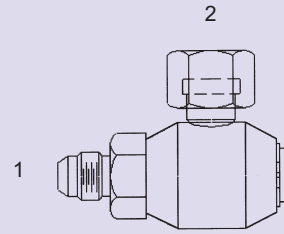

SLS-OFS-6510 - 90°

- (1) Male JIC - Stem
- (2) Fem. O-Ring Face Seal Swivel - Barrel

| | |
|--------------------|---------|
| SLS-OFS-6510-05-06 | 174.90 |
| SLS-OFS-6510-06-06 | 174.90 |
| SLS-OFS-6510-08-06 | 174.90 |
| SLS-OFS-6510-08-08 | 185.30 |
| SLS-OFS-6510-08-10 | 185.30 |
| SLS-OFS-6510-10-08 | 185.30 |
| SLS-OFS-6510-10-10 | 185.30 |
| SLS-OFS-6510-12-12 | 286.10 |
| SLS-OFS-6510-16-16 | 361.55 |
| SLS-OFS-6510-20-20 | 683.35 |
| SLS-OFS-6510-24-24 | 1392.45 |

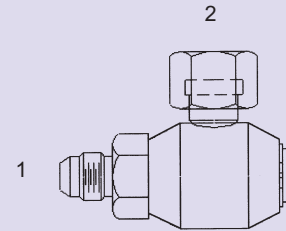

SLS-OFS-6510-5K - 90°

5000 PSI

- (1) Male JIC - Stem
- (2) Fem. O-Ring Face Seal Swivel - Barrel

| | |
|-----------------------|--------|
| SLS-OFS-6510-5K-05-06 | 260.10 |
| SLS-OFS-6510-5K-06-06 | 260.10 |
| SLS-OFS-6510-5K-06-08 | 260.10 |
| SLS-OFS-6510-5K-08-06 | 260.10 |
| SLS-OFS-6510-5K-08-08 | 260.10 |
| SLS-OFS-6510-5K-08-10 | 276.65 |
| SLS-OFS-6510-5K-10-08 | 276.65 |
| SLS-OFS-6510-5K-10-10 | 276.65 |

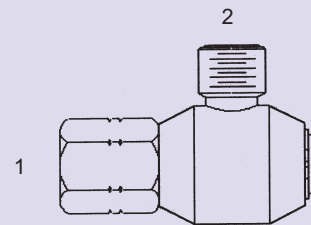

SLS-OFS-6560 - 90°

- (1) Fem. O-Ring Face Seal - Stem
- (2) Male O-Ring Face Seal - Barrel

| | |
|--------------------|---------|
| SLS-OFS-6560-04-04 | 178.60 |
| SLS-OFS-6560-06-06 | 174.90 |
| SLS-OFS-6560-08-08 | 174.90 |
| SLS-OFS-6560-10-10 | 185.30 |
| SLS-OFS-6560-12-12 | 286.10 |
| SLS-OFS-6560-16-16 | 361.55 |
| SLS-OFS-6560-20-20 | 683.35 |
| SLS-OFS-6560-24-24 | 1392.45 |

STEEL LIVE SWIVELS - O-RING FACE SEAL

Styles may vary from picture

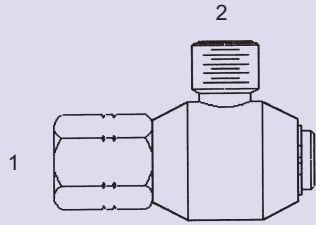

SLS-OFS-6560-4K - 90°

4000 PSI

- (1) Fem. O-Ring Face Seal - Stem
- (2) Male O-Ring Face Seal - Barrel

| | |
|-----------------------|---------|
| SLS-OFS-6560-4K-12-12 | 255.90 |
| SLS-OFS-6560-4K-16-16 | 312.40 |
| SLS-OFS-6560-4K-20-20 | 508.60 |
| SLS-OFS-6560-4K-24-24 | 1266.55 |

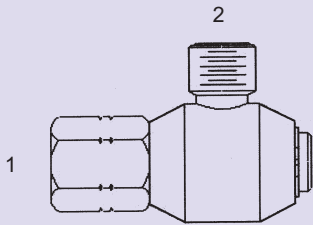

SLS-OFS-6560-5K - 90°

5000 PSI

- (1) Fem. O-Ring Face Seal - Stem
- (2) Male O-Ring Face Seal - Barrel

| | |
|-----------------------|--------|
| SLS-OFS-6560-5K-04-04 | 167.25 |
| SLS-OFS-6560-5K-04-06 | 260.10 |
| SLS-OFS-6560-5K-06-04 | 260.10 |
| SLS-OFS-6560-5K-06-06 | 260.10 |
| SLS-OFS-6560-5K-06-08 | 260.10 |
| SLS-OFS-6560-5K-08-06 | 260.10 |
| SLS-OFS-6560-5K-08-08 | 189.15 |
| SLS-OFS-6560-5K-08-10 | 276.65 |
| SLS-OFS-6560-5K-10-08 | 276.65 |
| SLS-OFS-6560-5K-10-10 | 189.15 |

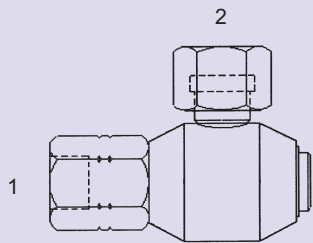

SLS-OFS-6565 - 90°

- (1) Fem. O-Ring Face Seal - Stem
- (2) Male O-Ring Face Seal Swivel - Barrel

| | |
|--------------------|---------|
| SLS-OFS-6565-06-06 | 174.90 |
| SLS-OFS-6565-08-06 | 174.90 |
| SLS-OFS-6565-08-08 | 185.30 |
| SLS-OFS-6565-08-10 | 185.30 |
| SLS-OFS-6565-10-10 | 185.30 |
| SLS-OFS-6565-12-12 | 286.10 |
| SLS-OFS-6565-16-16 | 361.55 |
| SLS-OFS-6565-20-20 | 683.35 |
| SLS-OFS-6565-24-24 | 1392.45 |

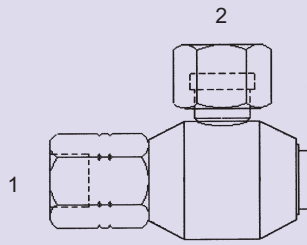

SLS-OFS-6565-5K - 90°

5000 PSI

- (1) Fem. O-Ring Face Seal - Stem
- (2) Male O-Ring Face Seal Swivel - Barrel

| | |
|-----------------------|--------|
| SLS-OFS-6565-5K-04-06 | 260.10 |
| SLS-OFS-6565-5K-06-06 | 260.10 |
| SLS-OFS-6565-5K-06-08 | 260.10 |
| SLS-OFS-6565-5K-08-06 | 260.10 |
| SLS-OFS-6565-5K-08-08 | 260.10 |
| SLS-OFS-6565-5K-08-10 | 276.65 |
| SLS-OFS-6565-5K-10-08 | 276.65 |
| SLS-OFS-6565-5K-10-10 | 276.65 |

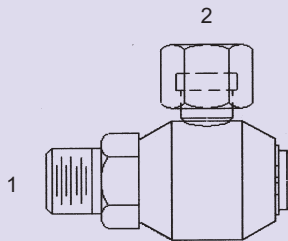

SLS-OFS-6570 - 90°

- (1) Male Pipe - Stem
- (2) Fem. O-Ring Face Seal Swivel - Barrel

| | |
|--------------------|---------|
| SLS-OFS-6570-04-04 | 178.60 |
| SLS-OFS-6570-04-06 | 174.90 |
| SLS-OFS-6570-06-06 | 174.90 |
| SLS-OFS-6570-08-08 | 185.30 |
| SLS-OFS-6570-08-10 | 185.30 |
| SLS-OFS-6570-12-12 | 286.10 |
| SLS-OFS-6570-16-16 | 361.55 |
| SLS-OFS-6570-20-20 | 683.35 |
| SLS-OFS-6570-24-24 | 1392.45 |

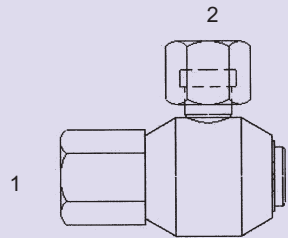

SLS-OFS-6580 - 90°

- (1) Fem. Pipe - Stem
- (2) Fem. O-Ring Face Seal Swivel - Barrel

| | |
|--------------------|---------|
| SLS-OFS-6580-04-06 | 174.90 |
| SLS-OFS-6580-06-06 | 174.90 |
| SLS-OFS-6580-08-08 | 185.30 |
| SLS-OFS-6580-08-10 | 185.30 |
| SLS-OFS-6580-12-12 | 286.10 |
| SLS-OFS-6580-16-16 | 361.55 |
| SLS-OFS-6580-20-20 | 683.35 |
| SLS-OFS-6580-24-24 | 1392.45 |

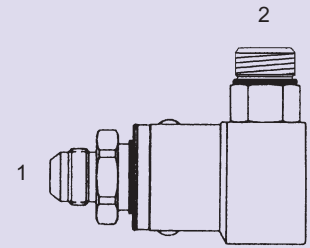

SLS-OFS-6816 - 90°

- (1) Male JIC - Stem
- (2) Male O-Ring Face Seal - Barrel

| | |
|--------------------|---------|
| SLS-OFS-6816-06-06 | 174.90 |
| SLS-OFS-6816-08-08 | 174.90 |
| SLS-OFS-6816-10-10 | 185.30 |
| SLS-OFS-6816-12-12 | 286.10 |
| SLS-OFS-6816-16-16 | 361.55 |
| SLS-OFS-6816-20-20 | 683.35 |
| SLS-OFS-6816-24-24 | 1392.45 |

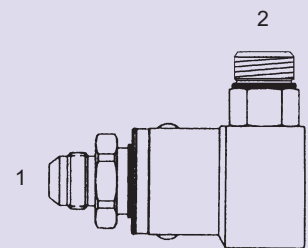

SLS-OFS-6816-4K - 90°

4000 PSI

- (1) Male JIC - Stem
- (2) Male O-Ring Face Seal - Barrel

| | |
|-----------------------|---------|
| SLS-OFS-6816-4K-12-12 | 255.90 |
| SLS-OFS-6816-4K-16-16 | 312.40 |
| SLS-OFS-6816-4K-20-20 | 508.60 |
| SLS-OFS-6816-4K-24-24 | 1266.55 |

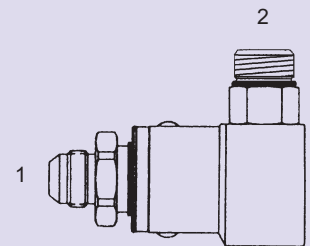

SLS-OFS-6816-5K - 90°

5000 PSI

- (1) Male JIC - Stem
- (2) Male O-Ring Face Seal - Barrel

| | |
|-----------------------|--------|
| SLS-OFS-6816-5K-05-04 | 260.10 |
| SLS-OFS-6816-5K-05-06 | 260.10 |
| SLS-OFS-6816-5K-06-04 | 260.10 |
| SLS-OFS-6816-5K-06-06 | 167.25 |
| SLS-OFS-6816-5K-06-08 | 260.10 |
| SLS-OFS-6816-5K-08-06 | 189.15 |
| SLS-OFS-6816-5K-08-08 | 189.15 |
| SLS-OFS-6816-5K-08-10 | 189.15 |
| SLS-OFS-6816-5K-10-08 | 189.15 |
| SLS-OFS-6816-5K-10-10 | 189.15 |

STEEL LIVE SWIVELS - O-RING FACE SEAL

Styles may vary from picture

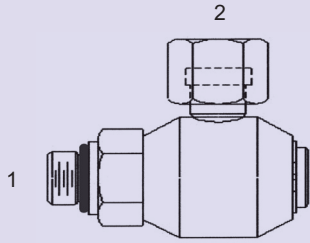

SLS-OFS-6840-O - 90°

- (1) Male O-Ring - Stem
- (2) Fem. O-Ring Face Seal Swivel - Barrel

| | |
|----------------------|---------|
| SLS-OFS-6840-04-06-O | 174.90 |
| SLS-OFS-6840-05-06-O | 174.90 |
| SLS-OFS-6840-06-06-O | 174.90 |
| SLS-OFS-6840-08-06-O | 174.90 |
| SLS-OFS-6840-08-08-O | 185.30 |
| SLS-OFS-6840-08-10-O | 185.30 |
| SLS-OFS-6840-10-08-O | 185.30 |
| SLS-OFS-6840-10-10-O | 185.30 |
| SLS-OFS-6840-12-08-O | 185.30 |
| SLS-OFS-6840-12-10-O | 185.30 |
| SLS-OFS-6840-12-12-O | 286.10 |
| SLS-OFS-6840-16-16-O | 361.55 |
| SLS-OFS-6840-20-20-O | 683.35 |
| SLS-OFS-6840-24-24-O | 1392.45 |

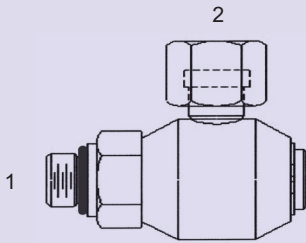

SLS-OFS-6840-5K-O - 90°

5000 PSI

- (1) Male O-Ring - Stem
- (2) Fem. O-Ring Face Seal Swivel - Barrel

| | |
|-------------------------|--------|
| SLS-OFS-6840-5K-05-06-O | 260.10 |
| SLS-OFS-6840-5K-06-06-O | 260.10 |
| SLS-OFS-6840-5K-06-08-O | 260.10 |
| SLS-OFS-6840-5K-08-06-O | 260.10 |
| SLS-OFS-6840-5K-08-08-O | 260.10 |
| SLS-OFS-6840-5K-08-10-O | 276.65 |
| SLS-OFS-6840-5K-10-08-O | 276.65 |
| SLS-OFS-6840-5K-10-10-O | 276.65 |

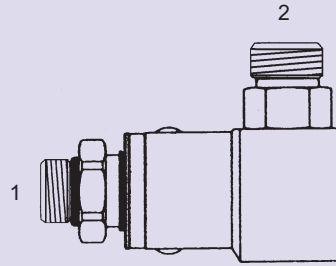

SLS-OFS-6846-O - 90°

- (1) Male O-Ring - Stem
- (2) Male O-Ring Face Seal - Barrel

| | |
|----------------------|---------|
| SLS-OFS-6846-04-04-O | 178.60 |
| SLS-OFS-6846-04-06-O | 174.90 |
| SLS-OFS-6846-05-08-O | 174.90 |
| SLS-OFS-6846-06-04-O | 174.90 |
| SLS-OFS-6846-06-06-O | 174.90 |
| SLS-OFS-6846-06-08-O | 174.90 |
| SLS-OFS-6846-08-06-O | 174.90 |
| SLS-OFS-6846-08-08-O | 174.90 |
| SLS-OFS-6846-08-10-O | 185.30 |
| SLS-OFS-6846-10-08-O | 185.30 |
| SLS-OFS-6846-10-10-O | 185.30 |
| SLS-OFS-6846-12-08-O | 185.30 |
| SLS-OFS-6846-12-10-O | 185.30 |
| SLS-OFS-6846-12-12-O | 286.10 |
| SLS-OFS-6846-16-16-O | 361.55 |
| SLS-OFS-6846-20-20-O | 683.35 |
| SLS-OFS-6846-24-24-O | 1392.45 |

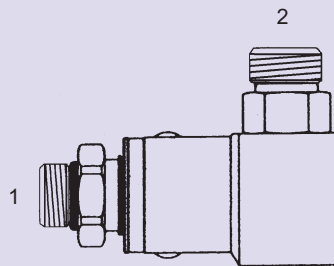

SLS-OFS-6846-4K-O - 90°

4000 PSI

- (1) Male O-Ring - Stem
- (2) Male O-Ring Face Seal - Barrel

| | |
|-------------------------|---------|
| SLS-OFS-6846-4K-12-12-O | 255.90 |
| SLS-OFS-6846-4K-16-16-O | 312.40 |
| SLS-OFS-6846-4K-20-20-O | 508.60 |
| SLS-OFS-6846-4K-24-24-O | 1266.55 |

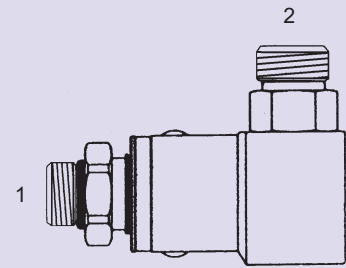

SLS-OFS-6846-5K-O - 90°

5000 PSI

- (1) Male O-Ring - Stem
- (2) Male O-Ring Face Seal - Barrel

| | |
|-------------------------|--------|
| SLS-OFS-6846-5K-05-04-O | 260.10 |
| SLS-OFS-6846-5K-05-06-O | 260.10 |
| SLS-OFS-6846-5K-06-04-O | 260.10 |
| SLS-OFS-6846-5K-06-06-O | 167.25 |
| SLS-OFS-6846-5K-06-08-O | 260.10 |
| SLS-OFS-6846-5K-08-06-O | 189.15 |
| SLS-OFS-6846-5K-08-08-O | 189.15 |
| SLS-OFS-6846-5K-08-10-O | 189.15 |
| SLS-OFS-6846-5K-10-08-O | 189.15 |
| SLS-OFS-6846-5K-10-10-O | 189.15 |

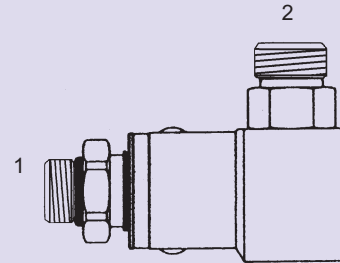

SLS-OFS-6846-LH - 90°

5000 PSI

Large Hex

- (1) Male O-Ring - Stem
- (2) Male O-Ring Face Seal - Barrel

| | |
|-------------------------|--------|
| SLS-OFS-6846-LH-08-08-O | 185.30 |
|-------------------------|--------|

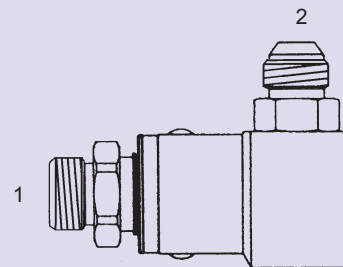

SLS-OFS-6861 - 90°

- (1) Male O-Ring Face Seal - Stem
- (2) Male JIC - Barrel

| | |
|--------------------|---------|
| SLS-OFS-6861-06-05 | 174.90 |
| SLS-OFS-6861-06-06 | 174.90 |
| SLS-OFS-6861-06-08 | 174.90 |
| SLS-OFS-6861-08-06 | 174.90 |
| SLS-OFS-6861-08-08 | 174.90 |
| SLS-OFS-6861-08-10 | 185.30 |
| SLS-OFS-6861-10-10 | 185.30 |
| SLS-OFS-6861-12-12 | 286.10 |
| SLS-OFS-6861-16-16 | 361.55 |
| SLS-OFS-6861-20-20 | 683.35 |
| SLS-OFS-6861-24-24 | 1392.45 |

STEEL LIVE SWIVELS - O-RING FACE SEAL

Styles may vary from picture

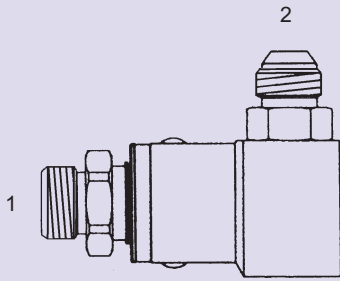

SLS-OFS-6861-5K - 90°

5000 PSI

- (1) Male O-Ring Face Seal - Stem
- (2) Male JIC - Barrel

| | |
|-----------------------|--------|
| SLS-OFS-6861-5K-04-05 | 260.10 |
| SLS-OFS-6861-5K-04-06 | 260.10 |
| SLS-OFS-6861-5K-06-05 | 260.10 |
| SLS-OFS-6861-5K-06-06 | 260.10 |
| SLS-OFS-6861-5K-06-08 | 260.10 |
| SLS-OFS-6861-5K-06-08 | 260.10 |
| SLS-OFS-6861-5K-08-06 | 260.10 |
| SLS-OFS-6861-5K-08-08 | 260.10 |
| SLS-OFS-6861-5K-08-10 | 276.65 |
| SLS-OFS-6861-5K-10-08 | 276.65 |
| SLS-OFS-6861-5K-10-10 | 276.65 |

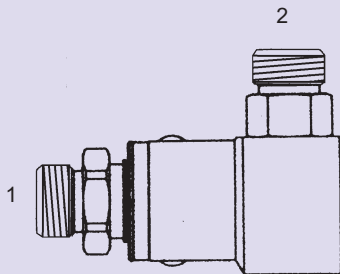

SLS-OFS-6866 - 90°

- (1) Male O-Ring Face Seal - Stem
- (2) Male O-Ring Face Seal - Barrel

| | |
|--------------------|---------|
| SLS-OFS-6866-04-04 | 178.60 |
| SLS-OFS-6866-06-06 | 174.90 |
| SLS-OFS-6866-06-08 | 174.90 |
| SLS-OFS-6866-08-06 | 174.90 |
| SLS-OFS-6866-08-08 | 174.90 |
| SLS-OFS-6866-08-10 | 185.30 |
| SLS-OFS-6866-10-10 | 185.30 |
| SLS-OFS-6866-12-12 | 286.10 |
| SLS-OFS-6866-16-16 | 361.55 |
| SLS-OFS-6866-20-20 | 683.35 |
| SLS-OFS-6866-24-24 | 1392.45 |

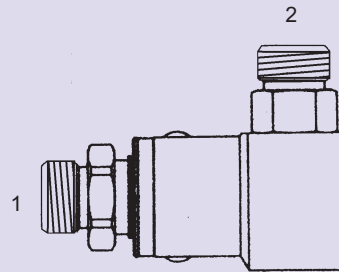

SLS-OFS-6866-4K - 90°

4000 PSI

- (1) Male O-Ring Face Seal - Stem
- (2) Male O-Ring Face Seal - Barrel

| | |
|-----------------------|---------|
| SLS-OFS-6866-4K-12-12 | 255.90 |
| SLS-OFS-6866-4K-16-16 | 312.40 |
| SLS-OFS-6866-4K-20-20 | 508.60 |
| SLS-OFS-6866-4K-24-24 | 1266.55 |

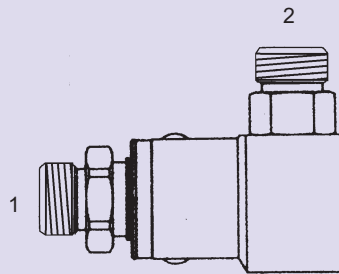

SLS-OFS-6866-5K - 90°

5000 PSI

- (1) Male O-Ring Face Seal - Stem
- (2) Male O-Ring Face Seal - Barrel

| | |
|-----------------------|--------|
| SLS-OFS-6866-5K-04-04 | 260.10 |
| SLS-OFS-6866-5K-04-06 | 260.10 |
| SLS-OFS-6866-5K-06-04 | 260.10 |
| SLS-OFS-6866-5K-06-06 | 167.25 |
| SLS-OFS-6866-5K-06-08 | 260.10 |
| SLS-OFS-6866-5K-08-06 | 260.10 |
| SLS-OFS-6866-5K-08-08 | 189.15 |
| SLS-OFS-6866-5K-08-10 | 276.65 |
| SLS-OFS-6866-5K-10-08 | 276.65 |
| SLS-OFS-6866-5K-10-10 | 189.15 |

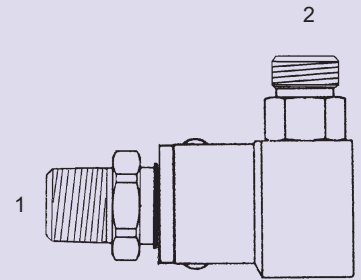

SLS-OFS-6876 - 90°

- (1) Male Pipe - Stem
- (2) Male O-Ring Face Seal - Barrel

| | |
|--------------------|---------|
| SLS-OFS-6876-04-04 | 178.60 |
| SLS-OFS-6876-04-06 | 174.90 |
| SLS-OFS-6876-06-06 | 174.90 |
| SLS-OFS-6876-06-08 | 174.90 |
| SLS-OFS-6876-08-08 | 185.30 |
| SLS-OFS-6876-08-10 | 185.30 |
| SLS-OFS-6876-12-12 | 286.10 |
| SLS-OFS-6876-16-16 | 361.55 |
| SLS-OFS-6876-20-20 | 683.35 |
| SLS-OFS-6876-24-24 | 1392.45 |

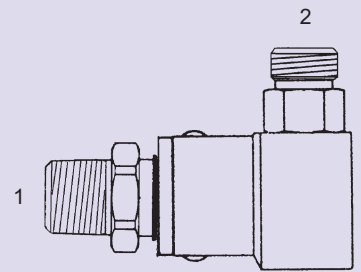

SLS-OFS-6876-4K - 90°

4000 PSI

- (1) Male Pipe - Stem
- (2) Male O-Ring Face Seal - Barrel

| | |
|-----------------------|---------|
| SLS-OFS-6876-4K-12-12 | 255.90 |
| SLS-OFS-6876-4K-16-16 | 312.40 |
| SLS-OFS-6876-4K-20-20 | 508.60 |
| SLS-OFS-6876-4K-24-24 | 1266.55 |

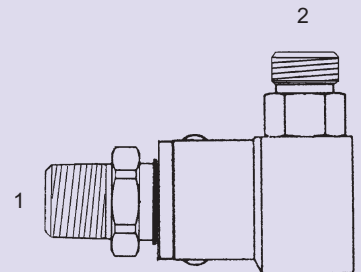

SLS-OFS-6876-5K - 90°

5000 PSI

- (1) Male Pipe - Stem
- (2) Male O-Ring Face Seal - Barrel

| | |
|-----------------------|--------|
| SLS-OFS-6876-5K-04-04 | 167.25 |
| SLS-OFS-6876-5K-06-06 | 167.25 |
| SLS-OFS-6876-5K-06-08 | 189.15 |
| SLS-OFS-6876-5K-08-08 | 189.15 |
| SLS-OFS-6876-5K-08-10 | 189.15 |

STEEL LIVE SWIVELS - O-RING FACE SEAL

Styles may vary from picture

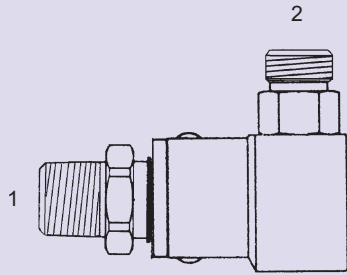

SLS-OFS-6876-5K-LH - 90°

5000 PSI
Large Hex

- (1) Male Pipe - Stem
- (2) Male O-Ring Face Seal - Barrel

SLS-OFS-6876-5K-LH-06-06 189.15

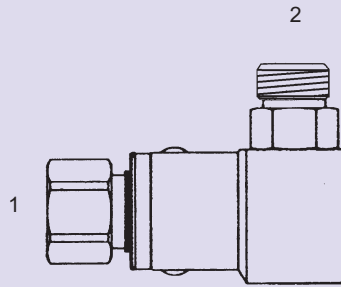

SLS-OFS-6886-4K - 90°

4000 PSI

- (1) Fem. Pipe - Stem
- (2) Male O-Ring Face Seal - Barrel

SLS-OFS-6886-4K-12-12 255.90
 SLS-OFS-6886-4K-16-16 312.40
 SLS-OFS-6886-4K-20-20 471.90
 SLS-OFS-6886-4K-24-24 1266.55

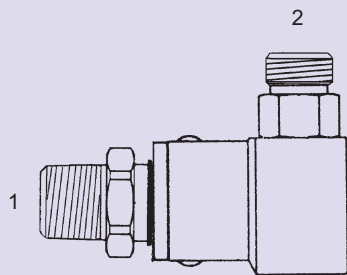

SLS-OFS-6876-LH - 90°

Large Hex

- (1) Male Pipe - Stem
- (2) Male O-Ring Face Seal - Barrel

SLS-OFS-6876-LH-06-06 189.15

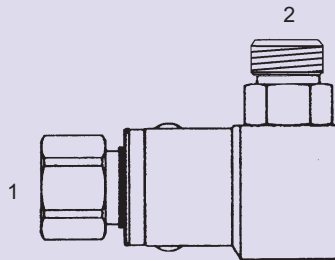

SLS-OFS-6886-5K - 90°

5000 PSI

- (1) Fem. Pipe - Stem
- (2) Male O-Ring Face Seal - Barrel

SLS-OFS-6886-5K-04-06 167.25
 SLS-OFS-6886-5K-06-06 189.15
 SLS-OFS-6886-5K-06-08 189.15
 SLS-OFS-6886-5K-08-08 189.15
 SLS-OFS-6886-5K-08-10 189.15

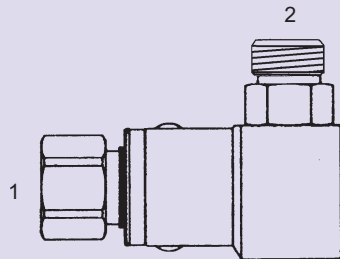

SLS-OFS-6886 - 90°

- (1) Fem. Pipe - Stem
- (2) Male O-Ring Face Seal - Barrel

SLS-OFS-6886-04-06 174.90
 SLS-OFS-6886-06-06 174.90
 SLS-OFS-6886-06-08 174.90
 SLS-OFS-6886-08-08 185.30
 SLS-OFS-6886-08-10 185.30
 SLS-OFS-6886-12-12 286.10
 SLS-OFS-6886-16-16 361.55
 SLS-OFS-6886-20-20 683.35
 SLS-OFS-6886-24-24 1392.45

STEEL LIVE SWIVELS -PARALLEL PLANE (180° 3000 PSI)

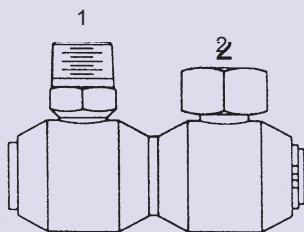

SLS-PP-1404

(1) Male Pipe - Stem
(2) Fem. Pipe Swivel - Barrel

| | |
|-------------------|---------|
| SLS-PP-1404-04-04 | 296.40 |
| SLS-PP-1404-04-06 | 296.40 |
| SLS-PP-1404-06-04 | 296.40 |
| SLS-PP-1404-06-06 | 296.40 |
| SLS-PP-1404-08-08 | 309.10 |
| SLS-PP-1404-12-12 | 512.25 |
| SLS-PP-1404-16-16 | 668.75 |
| SLS-PP-1404-20-20 | 1136.25 |
| SLS-PP-1404-24-24 | 2664.75 |
| SLS-PP-1404-32-32 | 3908.70 |

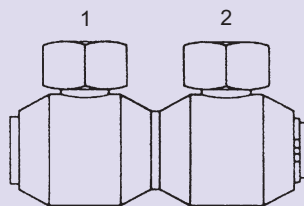

SLS-PP-1406

(1) (2) Fem. Pipe Swivel

| | |
|-------------------|---------|
| SLS-PP-1406-04-04 | 296.40 |
| SLS-PP-1406-06-06 | 296.40 |
| SLS-PP-1406-08-08 | 309.10 |
| SLS-PP-1406-12-12 | 512.25 |
| SLS-PP-1406-16-16 | 668.75 |
| SLS-PP-1406-20-20 | 1136.25 |
| SLS-PP-1406-24-24 | 2664.75 |
| SLS-PP-1406-32-32 | 3908.70 |

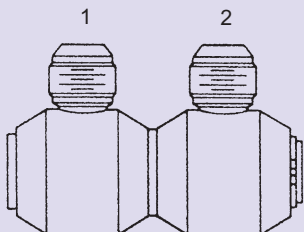

SLS-PP-2403

(1) (2) Male JIC

| | |
|-------------------|---------|
| SLS-PP-2403-05-05 | 296.40 |
| SLS-PP-2403-06-06 | 296.40 |
| SLS-PP-2403-08-08 | 296.40 |
| SLS-PP-2403-10-08 | 309.10 |
| SLS-PP-2403-10-10 | 309.10 |
| SLS-PP-2403-12-12 | 512.25 |
| SLS-PP-2403-16-16 | 668.75 |
| SLS-PP-2403-20-20 | 1136.25 |
| SLS-PP-2403-24-24 | 2664.75 |
| SLS-PP-2403-32-32 | 3908.70 |

Styles may vary from picture

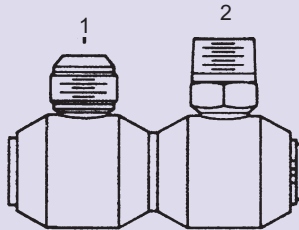

SLS-PP-2404

(1) Male JIC
(2) Male Pipe

| | |
|-------------------|---------|
| SLS-PP-2404-05-04 | 296.40 |
| SLS-PP-2404-06-04 | 296.40 |
| SLS-PP-2404-06-06 | 296.40 |
| SLS-PP-2404-08-04 | 296.40 |
| SLS-PP-2404-08-06 | 296.40 |
| SLS-PP-2404-08-08 | 309.10 |
| SLS-PP-2404-10-08 | 309.10 |
| SLS-PP-2404-12-12 | 512.25 |
| SLS-PP-2404-16-16 | 668.75 |
| SLS-PP-2404-20-20 | 1136.25 |
| SLS-PP-2404-24-24 | 2664.75 |
| SLS-PP-2404-32-32 | 3908.70 |

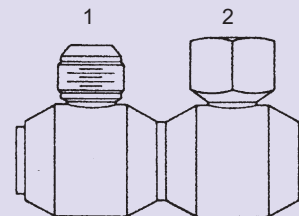

SLS-PP-2405

(1) Male JIC
(2) Fem. Pipe

| | |
|-------------------|---------|
| SLS-PP-2405-05-04 | 296.40 |
| SLS-PP-2405-05-06 | 296.40 |
| SLS-PP-2405-06-04 | 296.40 |
| SLS-PP-2405-06-06 | 296.40 |
| SLS-PP-2405-08-06 | 296.40 |
| SLS-PP-2405-08-08 | 309.10 |
| SLS-PP-2405-10-08 | 309.10 |
| SLS-PP-2405-12-12 | 512.25 |
| SLS-PP-2405-16-16 | 668.75 |
| SLS-PP-2405-20-20 | 1136.25 |
| SLS-PP-2405-24-24 | 2664.75 |
| SLS-PP-2405-32-32 | 3908.70 |

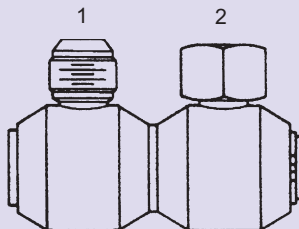

SLS-PP-2800

(1) Male JIC
(2) Fem. Pipe Swivel

| | |
|-------------------|--------|
| SLS-PP-2800-05-04 | 296.40 |
| SLS-PP-2800-05-06 | 296.40 |
| SLS-PP-2800-06-04 | 296.40 |
| SLS-PP-2800-06-06 | 296.40 |
| SLS-PP-2800-08-06 | 296.40 |
| SLS-PP-2800-08-08 | 309.10 |

| | |
|-------------------|---------|
| SLS-PP-2800-10-08 | 309.10 |
| SLS-PP-2800-12-12 | 512.25 |
| SLS-PP-2800-16-16 | 668.75 |
| SLS-PP-2800-20-20 | 1136.25 |
| SLS-PP-2800-24-24 | 2664.75 |
| SLS-PP-2800-32-32 | 3908.70 |

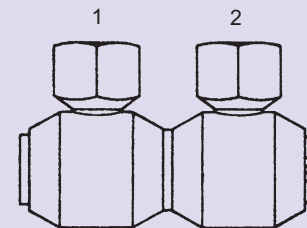

SLS-PP-5000

(1) Fem. Pipe
(2) Fem. Pipe

| | |
|-------------------|---------|
| SLS-PP-5000-04-04 | 296.40 |
| SLS-PP-5000-06-06 | 296.40 |
| SLS-PP-5000-08-08 | 309.10 |
| SLS-PP-5000-12-12 | 512.25 |
| SLS-PP-5000-16-16 | 668.75 |
| SLS-PP-5000-20-20 | 1136.25 |
| SLS-PP-5000-24-24 | 2664.75 |
| SLS-PP-5000-32-32 | 3908.70 |

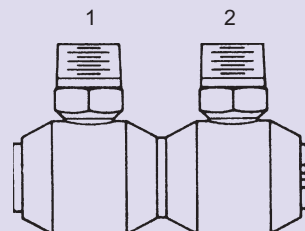

SLS-PP-5404

(1) (2) Male Pipe

| | |
|-------------------|---------|
| SLS-PP-5404-04-04 | 296.40 |
| SLS-PP-5404-06-06 | 296.40 |
| SLS-PP-5404-08-08 | 309.10 |
| SLS-PP-5404-12-12 | 512.25 |
| SLS-PP-5404-16-16 | 668.75 |
| SLS-PP-5404-20-20 | 1136.25 |
| SLS-PP-5404-24-24 | 2664.75 |
| SLS-PP-5404-32-32 | 3908.70 |

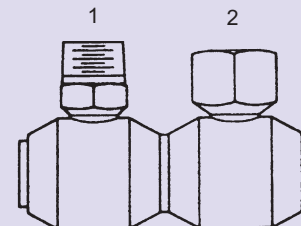

SLS-PP-5405

(1) Male Pipe
(2) Fem. Pipe

| | |
|-------------------|---------|
| SLS-PP-5405-04-04 | 296.40 |
| SLS-PP-5405-04-06 | 296.40 |
| SLS-PP-5405-06-06 | 296.40 |
| SLS-PP-5405-08-08 | 309.10 |
| SLS-PP-5405-12-12 | 512.25 |
| SLS-PP-5405-16-16 | 668.75 |
| SLS-PP-5405-20-20 | 1136.25 |
| SLS-PP-5405-24-24 | 2664.75 |
| SLS-PP-5405-32-32 | 3908.70 |

STEEL LIVE SWIVELS -PARALLEL PLANE (180° 3000 PSI)

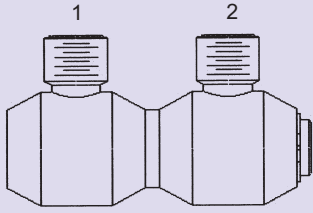

SLS-PP-OFS-2403

- (1) Male O-Ring Face Seal
- (2) Male O-Ring Face Seal

| | |
|-----------------------|---------|
| SLS-PP-OFS-2403-04-04 | 348.70 |
| SLS-PP-OFS-2403-06-04 | 348.70 |
| SLS-PP-OFS-2403-06-06 | 348.70 |
| SLS-PP-OFS-2403-08-04 | 348.70 |
| SLS-PP-OFS-2403-08-08 | 348.70 |
| SLS-PP-OFS-2403-10-08 | 363.60 |
| SLS-PP-OFS-2403-10-10 | 363.60 |
| SLS-PP-OFS-2403-12-12 | 602.60 |
| SLS-PP-OFS-2403-16-16 | 786.75 |
| SLS-PP-OFS-2403-20-20 | 1336.70 |
| SLS-PP-OFS-2403-24-24 | 3134.95 |

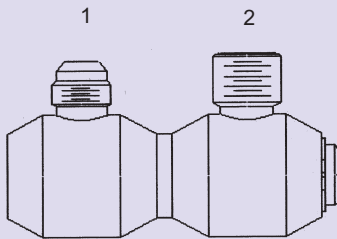

SLS-PP-OFS-6416

- (1) Male JIC
- (2) Male O-Ring Face Seal

| | |
|-----------------------|---------|
| SLS-PP-OFS-6416-06-06 | 348.70 |
| SLS-PP-OFS-6416-08-08 | 348.70 |
| SLS-PP-OFS-6416-10-10 | 363.60 |
| SLS-PP-OFS-6416-12-12 | 602.60 |
| SLS-PP-OFS-6416-16-16 | 786.75 |
| SLS-PP-OFS-6416-20-20 | 1336.70 |
| SLS-PP-OFS-6416-24-24 | 3134.95 |

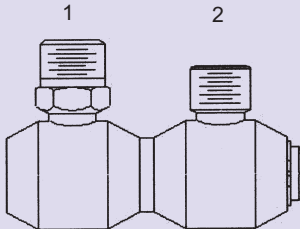

SLS-PP-OFS-6476

- (1) Male Pipe
- (2) Male O-Ring Face Seal

| | |
|-----------------------|---------|
| SLS-PP-OFS-6476-04-06 | 348.70 |
| SLS-PP-OFS-6476-06-08 | 348.70 |
| SLS-PP-OFS-6476-08-10 | 363.60 |
| SLS-PP-OFS-6476-12-12 | 602.60 |
| SLS-PP-OFS-6476-16-16 | 786.75 |
| SLS-PP-OFS-6476-20-20 | 1336.70 |
| SLS-PP-OFS-6476-24-24 | 3134.95 |

Styles may vary from picture

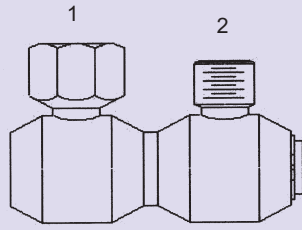

SLS-PP-OFS-6486

- (1) Fem. Pipe
- (2) Male O-Ring Face Seal

| | |
|-----------------------|---------|
| SLS-PP-OFS-6486-04-06 | 348.70 |
| SLS-PP-OFS-6486-06-08 | 348.70 |
| SLS-PP-OFS-6486-08-10 | 363.60 |
| SLS-PP-OFS-6486-12-12 | 602.60 |
| SLS-PP-OFS-6486-16-16 | 786.75 |
| SLS-PP-OFS-6486-20-20 | 1336.70 |
| SLS-PP-OFS-6486-24-24 | 3134.95 |

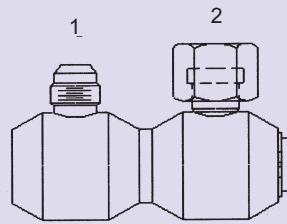

SLS-PP-OFS-6510

- (1) Male JIC
- (2) Fem. O-Ring Face Seal

| | |
|-----------------------|---------|
| SLS-PP-OFS-6510-05-06 | 348.70 |
| SLS-PP-OFS-6510-06-06 | 348.70 |
| SLS-PP-OFS-6510-08-06 | 348.70 |
| SLS-PP-OFS-6510-08-08 | 363.60 |
| SLS-PP-OFS-6510-08-10 | 363.60 |
| SLS-PP-OFS-6510-10-08 | 363.60 |
| SLS-PP-OFS-6510-10-10 | 363.60 |
| SLS-PP-OFS-6510-12-12 | 602.60 |
| SLS-PP-OFS-6510-16-16 | 786.75 |
| SLS-PP-OFS-6510-20-20 | 1336.70 |
| SLS-PP-OFS-6510-24-24 | 3134.95 |

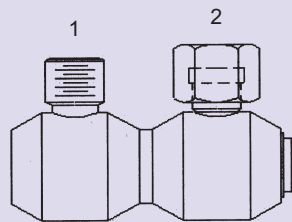

SLS-PP-OFS-6560

- (1) Male O-Ring Face Seal
- (2) Fem. O-Ring Face Seal Swivel

| | |
|-----------------------|---------|
| SLS-PP-OFS-6560-04-06 | 348.70 |
| SLS-PP-OFS-6560-06-06 | 348.70 |
| SLS-PP-OFS-6560-08-06 | 348.70 |
| SLS-PP-OFS-6560-08-08 | 363.60 |
| SLS-PP-OFS-6560-08-10 | 363.60 |
| SLS-PP-OFS-6560-10-08 | 363.60 |
| SLS-PP-OFS-6560-10-10 | 363.60 |
| SLS-PP-OFS-6560-12-12 | 602.60 |
| SLS-PP-OFS-6560-16-16 | 786.75 |
| SLS-PP-OFS-6560-20-20 | 1336.70 |
| SLS-PP-OFS-6560-24-24 | 3134.95 |

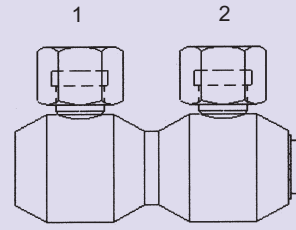

SLS-PP-OFS-6565

- (1) Fem. O-Ring Face Seal Swivel
- (2) Fem. O-Ring Face Seal Swivel

| | |
|-----------------------|---------|
| SLS-PP-OFS-6565-06-06 | 348.70 |
| SLS-PP-OFS-6565-08-08 | 363.60 |
| SLS-PP-OFS-6565-10-08 | 363.60 |
| SLS-PP-OFS-6565-10-10 | 363.60 |
| SLS-PP-OFS-6565-12-12 | 602.60 |
| SLS-PP-OFS-6565-16-16 | 786.75 |
| SLS-PP-OFS-6565-20-20 | 1336.70 |
| SLS-PP-OFS-6565-24-24 | 3134.95 |

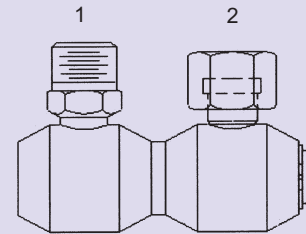

SLS-PP-OFS-6570

- (1) Fem. O-Ring Face Seal Swivel
- (2) Male Pipe

| | |
|-----------------------|---------|
| SLS-PP-OFS-6570-04-06 | 348.70 |
| SLS-PP-OFS-6570-06-06 | 348.70 |
| SLS-PP-OFS-6570-08-08 | 363.60 |
| SLS-PP-OFS-6570-08-10 | 363.60 |
| SLS-PP-OFS-6570-12-12 | 602.55 |
| SLS-PP-OFS-6570-16-16 | 786.75 |
| SLS-PP-OFS-6570-20-20 | 1336.70 |
| SLS-PP-OFS-6570-24-24 | 3134.90 |

STAINLESS STEEL LIVE SWIVELS -PARALLEL PLANE- O-RING FACE SEAL

Styles may vary from picture

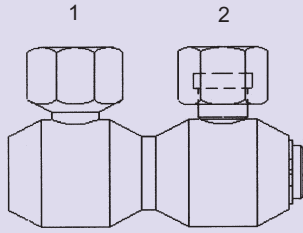

SLS-PP-OFS-6580

- (1) Fem. Pipe
- (2) Fem. O-Ring Face Seal Swivel

| | |
|-----------------------|---------|
| SLS-PP-OFS-6580-04-06 | 348.70 |
| SLS-PP-OFS-6580-06-06 | 348.70 |
| SLS-PP-OFS-6580-08-08 | 363.60 |
| SLS-PP-OFS-6580-08-10 | 363.60 |
| SLS-PP-OFS-6580-12-12 | 602.55 |
| SLS-PP-OFS-6580-16-16 | 786.75 |
| SLS-PP-OFS-6580-20-20 | 1336.70 |
| SLS-PP-OFS-6580-24-24 | 3134.90 |

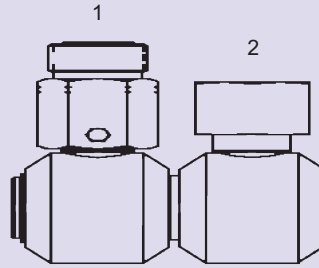

SLS-OFS-DP-PP-6500

- (1) Male O-Ring Face Seal
- (2) Fem. O-Ring Face Seal

| | |
|--------------------------|--------|
| SLS-OFS-DP-PP-6500-12-12 | 701.25 |
|--------------------------|--------|

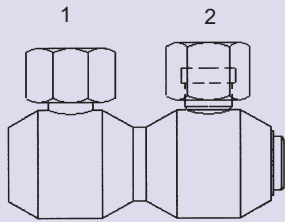

SLS-PP-OFS-6590

- (1) Fem. Pipe Swivel
- (2) Fem. O-Ring Face Seal Swivel

| | |
|-----------------------|---------|
| SLS-PP-OFS-6590-04-06 | 348.70 |
| SLS-PP-OFS-6590-08-08 | 363.60 |
| SLS-PP-OFS-6590-08-10 | 363.60 |
| SLS-PP-OFS-6590-12-12 | 602.60 |
| SLS-PP-OFS-6590-16-16 | 786.75 |
| SLS-PP-OFS-6590-20-20 | 1336.70 |
| SLS-PP-OFS-6590-24-24 | 3134.95 |

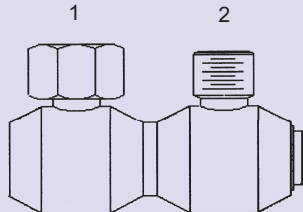

SLS-PP-OFS-6596

- (1) Fem. Pipe Swivel
- (2) Male O-Ring Face Seal

| | |
|-----------------------|---------|
| SLS-PP-OFS-6596-04-06 | 348.70 |
| SLS-PP-OFS-6596-06-08 | 348.70 |
| SLS-PP-OFS-6596-08-10 | 363.60 |
| SLS-PP-OFS-6596-12-12 | 602.60 |
| SLS-PP-OFS-6596-16-16 | 786.75 |
| SLS-PP-OFS-6596-20-20 | 1336.70 |
| SLS-PP-OFS-6596-24-24 | 3134.95 |

STAINLESS STEEL LIVE SWIVELS

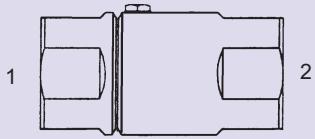

SS-LS-5000

- (1) Fem. Pipe - Stem
- (2) Fem. Pipe - Barrel

| | |
|------------------|---------|
| SS-LS-5000-04-04 | 585.75 |
| SS-LS-5000-06-06 | 606.00 |
| SS-LS-5000-08-08 | 641.40 |
| SS-LS-5000-12-12 | 803.55 |
| SS-LS-5000-16-16 | 1093.85 |
| SS-LS-5000-20-20 | 1403.00 |
| SS-LS-5000-24-24 | 3305.85 |
| SS-LS-5000-32-32 | 4209.60 |

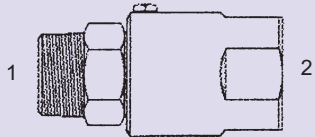

SS-LS-5405

- (1) Male Pipe - Stem
- (2) Fem. Pipe - Barrel

| | |
|------------------|---------|
| SS-LS-5405-04-04 | 585.75 |
| SS-LS-5405-06-06 | 606.00 |
| SS-LS-5405-08-08 | 641.30 |
| SS-LS-5405-12-12 | 803.55 |
| SS-LS-5405-16-16 | 1129.25 |

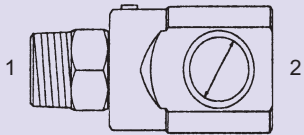

SS-LS-5502-SB - 90°

- (1) Male Pipe - Stem
- (2) Fem. Pipe - Barrel
(Short Body)

| | |
|---------------------|---------|
| SS-LS-5502-SB-04-04 | 648.55 |
| SS-LS-5502-SB-06-06 | 657.55 |
| SS-LS-5502-SB-08-08 | 657.55 |
| SS-LS-5502-SB-12-12 | 926.30 |
| SS-LS-5502-SB-16-16 | 1150.85 |

Styles may vary from picture

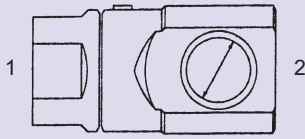

SS-LS-5504-SB - 90°

- (1) Male Pipe - Stem
- (2) Fem. Pipe - Barrel
(Short Body)

| | |
|---------------------|---------|
| SS-LS-5504-SB-04-04 | 648.55 |
| SS-LS-5504-SB-06-06 | 657.55 |
| SS-LS-5504-SB-08-08 | 657.55 |
| SS-LS-5504-SB-12-12 | 926.30 |
| SS-LS-5504-SB-16-16 | 1150.85 |
| SS-LS-5504-SB-20-20 | 1415.85 |
| SS-LS-5504-SB-24-24 | 3305.85 |
| SS-LS-5504-SB-32-32 | 4326.90 |

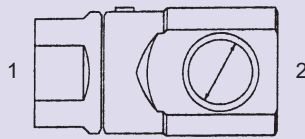

SS-LS-5504-SB-HP - 90°

High Pressure

- (1) Male Pipe - Stem
- (2) Fem. Pipe - Barrel
(Short Body)

| | |
|------------------------|--------|
| SS-LS-5504-SB-HP-12-12 | 926.40 |
|------------------------|--------|

PARTS INDEX

| | | | | | |
|----------------------|---|--------------------------|----|--------------------------|----|
| SLS-1501 | 1 | SLS-6841-4K-O | 8 | SLS-OFS-6580 | 17 |
| SLS-1501-4K | 1 | SLS-6841-5K-O | 9 | SLS-OFS-6816 | 17 |
| SLS-1501-5K | 1 | SLS-6841-LH-O | 9 | SLS-OFS-6816-4K | 17 |
| SLS-1502 | 1 | SLS-6843-O | 9 | SLS-OFS-6816-5K | 17 |
| SLS-1502-4K | 1 | SLS-6843-4K-O | 9 | SLS-OFS-6840-O | 18 |
| SLS-1502-5K | 1 | SLS-6845-O | 9 | SLS-OFS-6840-5K-O | 18 |
| SLS-1704-61 | 1 | SLS-6845-SB-O | 9 | SLS-OFS-6846-O | 18 |
| SLS-1704-62 | 1 | SLS-6849-O | 9 | SLS-OFS-6846-4K-O | 18 |
| SLS-2403 | 1 | SLS-6901-O | 9 | SLS-OFS-6846-5K-O | 18 |
| SLS-2405 | 2 | SLS-6975-SB | 9 | SLS-OFS-6846-LH-O | 18 |
| SLS-2412 | 2 | SLS-6985-SB | 9 | SLS-OFS-6861 | 18 |
| SLS-2421 | 2 | SLS-DP-2500 | 10 | SLS-OFS-6861-5K | 19 |
| SLS-2471 | 2 | SLS-DP-2500-4K | 10 | SLS-OFS-6866 | 19 |
| SLS-2472 | 2 | SLS-DP-2500-5K | 10 | SLS-OFS-6866-4K | 19 |
| SLS-2481 | 2 | SLS-DP-2502 | 10 | SLS-OFS-6866-5K | 19 |
| SLS-2500 | 2 | SLS-DP-2571 | 10 | SLS-OFS-6876 | 19 |
| SLS-2500-4K | 2 | SLS-DP-2571-4K | 10 | SLS-OFS-6876-4K | 19 |
| SLS-2500-5K | 2 | SLS-DP-2571-5K | 10 | SLS-OFS-6876-5K | 19 |
| SLS-2500-LH | 3 | SLS-DP-2581 | 11 | SLS-OFS-6876-5K-LH | 20 |
| SLS-2501 | 3 | SLS-DP-5502 | 11 | SLS-OFS-6876-LH | 20 |
| SLS-2502 | 3 | SLS-DP-5502-4K | 11 | SLS-OFS-6886 | 20 |
| SLS-2502-SB | 3 | SLS-DP-5502-5K | 11 | SLS-OFS-6886-4K | 20 |
| SLS-2519 | 3 | SLS-DP-5504 | 11 | SLS-OFS-6886-5K | 20 |
| SLS-2571 | 3 | SLS-DP-5504-4K | 11 | SLS-OFS-DP-PP-6500 | 23 |
| SLS-2571-4K | 4 | SLS-DP-5504-5K | 11 | SLS-PP-1404 | 21 |
| SLS-2571-5K | 4 | SLS-DP-6805-O | 11 | SLS-PP-1406 | 21 |
| SLS-2573 | 4 | SLS-DP-6841-O | 12 | SLS-PP-2403 | 21 |
| SLS-2573-4K | 4 | SLS-DP-6841-4K-O | 12 | SLS-PP-2404 | 21 |
| SLS-2573-5K | 4 | SLS-DP-6841-5K-O | 12 | SLS-PP-2405 | 21 |
| SLS-2581 | 4 | SLS-DP-OFS-6816 | 12 | SLS-PP-2800 | 21 |
| SLS-2581-4K | 4 | SLS-DP-OFS-6846-O | 12 | SLS-PP-5000 | 21 |
| SLS-2583 | 4 | SLS-DP-OFS-6846-4K | 12 | SLS-PP-5404 | 21 |
| SLS-2583-4K | 5 | SLS-DP-OFS-6846-5K | 12 | SLS-PP-5405 | 21 |
| SLS-2710 | 5 | SLS-DP-OFS-6861 | 12 | SLS-PP-OFS-2403 | 22 |
| SLS-2711 | 5 | SLS-DP-OFS-6866 | 13 | SLS-PP-OFS-6416 | 22 |
| SLS-2712 | 5 | SLS-DP-OFS-6866-4K | 13 | SLS-PP-OFS-6476 | 22 |
| SLS-2715-SB | 5 | SLS-DP-OFS-6866-5K | 13 | SLS-PP-OFS-6486 | 22 |
| SLS-2717 | 5 | SLS-DP-OFS-6868 | 13 | SLS-PP-OFS-6510 | 22 |
| SLS-2718-SB | 5 | SLS-DP-OFS-6876 | 13 | SLS-PP-OFS-6560 | 22 |
| SLS-2719 | 5 | SLS-DP-OFS-6886 | 13 | SLS-PP-OFS-6565 | 22 |
| SLS-5000 | 5 | SLS-OFS-2406 | 14 | SLS-PP-OFS-6570 | 22 |
| SLS-5000-HP | 6 | SLS-OFS-2507 | 14 | SLS-PP-OFS-6580 | 23 |
| SLS-5405 | 6 | SLS-OFS-2509 | 14 | SLS-PP-OFS-6590 | 23 |
| SLS-5405-HP | 6 | SLS-OFS-2510 | 14 | SLS-PP-OFS-6596 | 23 |
| SLS-5500 | 6 | SLS-OFS-2510-5K | 14 | SS-LS-5000 | 24 |
| SLS-5502 | 6 | SLS-OFS-2567 | 14 | SS-LS-5405 | 24 |
| SLS-5502-SB | 6 | SLS-OFS-2700-LN | 15 | SS-LS-5502-SB | 24 |
| SLS-5502-SB-HP | 6 | SLS-OFS-2701-LN-4K | 15 | SS-LS-5504-SB | 24 |
| SLS-5504 | 6 | SLS-OFS-2701-LN-5K | 15 | SS-LS-5504-SB-HP | 24 |
| SLS-5504-SB | 6 | SLS-OFS-2716-LN-4K | 15 | | |
| SLS-5504-SB-HP | 7 | SLS-OFS-2716-LN-5K | 15 | | |
| SLS-5587 | 7 | SLS-OFS-6426 | 15 | | |
| SLS-6402-O | 7 | SLS-OFS-6446-O | 15 | | |
| SLS-6441-O | 7 | SLS-OFS-6461 | 15 | | |
| SLS-6448-O | 7 | SLS-OFS-6466 | 16 | | |
| SLS-6455 | 7 | SLS-OFS-6468 | 16 | | |
| SLS-6513 | 7 | SLS-OFS-6476 | 16 | | |
| SLS-6513-4K | 7 | SLS-OFS-6500 | 16 | | |
| SLS-6573 | 7 | SLS-OFS-6500-5K | 16 | | |
| SLS-6573-4K | 8 | SLS-OFS-6510 | 16 | | |
| SLS-6805-O | 8 | SLS-OFS-6510-5K | 16 | | |
| SLS-6805-SB-O | 8 | SLS-OFS-6560 | 16 | | |
| SLS-6806-O | 8 | SLS-OFS-6560-4K | 17 | | |
| SLS-6814-4K-O | 8 | SLS-OFS-6560-5K | 17 | | |
| SLS-6814-5K-O | 8 | SLS-OFS-6565 | 17 | | |
| SLS-6815-SB | 8 | SLS-OFS-6565-5K | 17 | | |
| SLS-6841-O | 8 | SLS-OFS-6570 | 17 | | |



FITTINGS UNLIMITED, INC.

Adapter & Fitting Specialist

1-800-348-8467